



DOBOT

User Guide

Dobot Magician Go

User Guide

Issue: V1.0

Date: 2021-09-14

Shenzhen Yuejiang Technology Co., Ltd.

Copyright © Shenzhen Yuejiang Technology Co., Ltd. 2021. All rights reserved.

No part of this document may be reproduced or transmitted in any form or by any means without the prior written consent of Yuejiang Technology Co., Ltd..

Disclaimer

To the maximum extent permitted by applicable law, the products described (including its hardware, software, and firmware, etc.) in this document are provided **AS IS**, which may have flaws, errors or faults. Yuejiang makes no warranties of any kind, express or implied, including but not limited to, merchantability, satisfaction of quality, fitness for a particular purpose and non-infringement of third party rights. In no event will Yuejiang be liable for any special, incidental, consequential or indirect damages resulting from the use of our products and documents.

Before using our product, please thoroughly read and understand the contents of this document and related technical documents that are published online, to ensure that the robot is used on the premise of fully understanding the robot and related knowledge. Please use this document with technical guidance from professionals. Even if follow this document or any other related instructions, Damages or losses will be happening in the using process, Dobot shall not be considered as a guarantee regarding all security information contained in this document.

The user has the responsibility to make sure following the relevant practical laws and regulations of the country, in order that there is no significant danger in the use of the robot.

Shenzhen Yuejiang Technology Co., Ltd.

Address: Address: Floor 9-10, Building 2, Chongwen Garden, Nanshan iPark, Liuxian Blvd,
Nanshan District, Shenzhen, Guangdong Province, China

Website: www.dobot.cc

Preface

Purpose

This manual introduces the functions, technical specifications and operation of Dobot Magician Go (Hereinafter referred to as Magician Go), which is convenient for users to understand and use Magician Go.

Intended Audience

This document is intended for:





- Customer
- Sales Engineer
- Installation and Commissioning Engineer
- Technical Support Engineer

Change History

Date	Change Description
2021/09/14	The First release

Symbol Conventions

The symbols that may be founded in this document are defined as follows.

Symbol	Description
 DANGER	Indicates a hazard with a high level of risk which, if not avoided, could result in death or serious injury
 WARNING	Indicates a hazard with a medium level or low level of risk which, if not avoided, could result in minor or moderate injury, robot damage
 NOTICE	Indicates a potentially hazardous situation which, if not avoided, can result in equipment damage, data loss, or unanticipated result
 NOTE	Provides additional information to emphasize or supplement important points in the main text

Contents

1. Safety Precautions.....	1
1.1 General security	1
1.2 Power Box security	2
2. Introduction.....	3
2.1 Overview.....	3
2.2 Description on parts of Magician Go.....	3
2.2.1 Magic Box	5
2.2.2 Power Box	7
2.2.3 Mecanum wheels	8
2.2.4 Status indicator LEDs.....	9
2.2.5 AI camera	10
2.3 Technical specifications	12
2.3.1 Technical parameters	12
2.3.2 Dimensions	13
3. Wiring	15
3.1 Wiring of Magic Box	15
3.2 Wiring of Magician Lite.....	17
3.3 Wiring of arm AI camera	18
4. Operation	21
4.1 Control mode	21
4.1.1 Remote control mode	21
4.1.2 Bluetooth control mode	24
4.1.3 Wired control mode	26
4.1.4 Script control mode	27
4.2 DobotLab operation	28
4.2.1 Introduction on DobotLab	28
4.2.2 Instruction on DobotBlock Lab	29
4.2.3 Instruction on Python Lab	34
4.2.4 Arm camera calibration	39
5. About Map.....	45
5.1 Introduction on map and accessories	45
5.2 Reset.....	51
5.3 Demo.....	52

1. Safety Precautions

This section describes the security precautions that should be noticed when you use this product. Please read this document carefully before using the robot arm for the first time. This product needs to be used in an environment meeting design specification. You cannot remold the product without authorization, otherwise, it could lead to product failure, and even personal injury, electric shock, fire, etc. The installation personnel, operators, teaching personnel, and programmers must read this document carefully and use the robot arm strictly according to the regulations of this document.

1.1 General security



The robot arm is electrical equipment. Non-professional technicians cannot modify the wire, otherwise, it may cause equipment damage or personal injury.

Please follow the following security rules when using Magician Go.

- You should comply with local laws and regulations when operating Magician Go. The security precautions in this document are only supplemental to local laws and regulations.
- The **DANGER**, **WARNING**, and **NOTICE** marks in this document are only supplemental to the security precautions.
- Please use Magician Go within the specified environment scope. Exceeding the specifications and load conditions will shorten the service life of the product and even damage the equipment.
- Before operating and maintaining Magician Go, the personnel responsible for the installation, operation, and maintenance must be trained to understand the various security precautions and to master the correct methods of operation and maintenance.
- Highly corrosive cleaning is not suited to cleaning Magician Go. The anodized components are not suitable for immersion cleaning.
- People cannot repair and disassemble Magician Go without professional training. If there is a problem with the product, please contact Dobot technical support engineer in time.
- Please comply with the relevant laws to deal with the product which is scrapped, and protect the environment.
- There are small parts in the packing box, Please keep them away from children to avoid any accidents.
- DO NOT let children play with Magician Go alone. All processes need to be monitored while running. After processes have finished, please turn off the equipment promptly.
- DO NOT touch the workspace of Magician Go while it is running to avoid bruising

or pinching.

- It is prohibited to modify or remove the nameplates, instructions, icons, and marks on Magician Go and the related equipment.
- Be careful when carrying or installing Magician Go. Please follow the instructions on the packing box to put down Magician Go gently and place it correctly in direction of the arrow.
- Please refer to *Magician Go Quick Start* along with the packing box before using it.
- Please disconnect or connect external devices (such as AI camera kit, etc.) when Magician Go is completely powered off, otherwise it may cause damage on Magician Go.

1.2 Power Box security

The following basic precautions should be followed when using this product.

- Magician Go has built-in Power Box. Do not use or place Power Box under high temperature. Do not make Power Box short circuited, disassembled or soaked.
- Use of a power supply or charger not recommended or sold by power pack manufacturer may result in a risk of fire or injury to persons.
- Do not use Power Box in excess of its output rating. Overload outputs above rating may result in a risk of fire or injury to persons.
- Do not use Power Box that is damaged or modified. Damaged or modified batteries may exhibit unpredictable behavior resulting in fire, explosion or risk of injury.
- Do not disassemble Power Box. Incorrect reassembly may result in a risk of fire or injury to persons.
- Do not expose Power Box to fire or excessive temperature. Exposure to fire or temperature above 100°C (212°F) may cause explosion.
- Switch off the power when it is not in use.
- Do not use Power Box in a place with strong static electricity or magnetic field. Otherwise, the safety protection device of Power Box may be damaged, resulting in potential safety risks.
- If the Power Box is deformed or there is any abnormality in the process of use, storage or charging, please stop using it immediately and ask professional personnel for detection.

2. Introduction

2.1 Overview

Magician Go is an omnidirectional intelligent mobile chassis designed for Magician Lite robot arm (hereinafter referred to as Magician Lite). You can make Magician Lite move by operating Magician Go.

- With Mecanum wheels, Magician Go can move omnidirectionally and freely.
- With abundant sensor modules, Magician Go can realize interesting functions such as line patrol and obstacle avoidance.
- With arm AI camera and built-in chassis AI camera, Magician Go can be used in various scenes.
- With multiple control modes, Magician Go can be operated easily and flexibly.

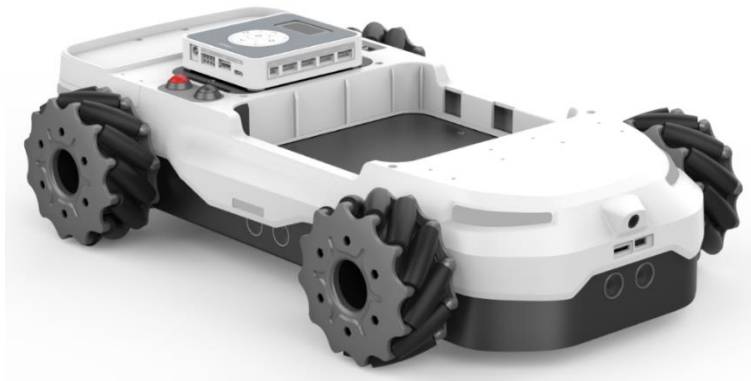

Figure 2.1 Magician Go

2.2 Description on parts of Magician Go

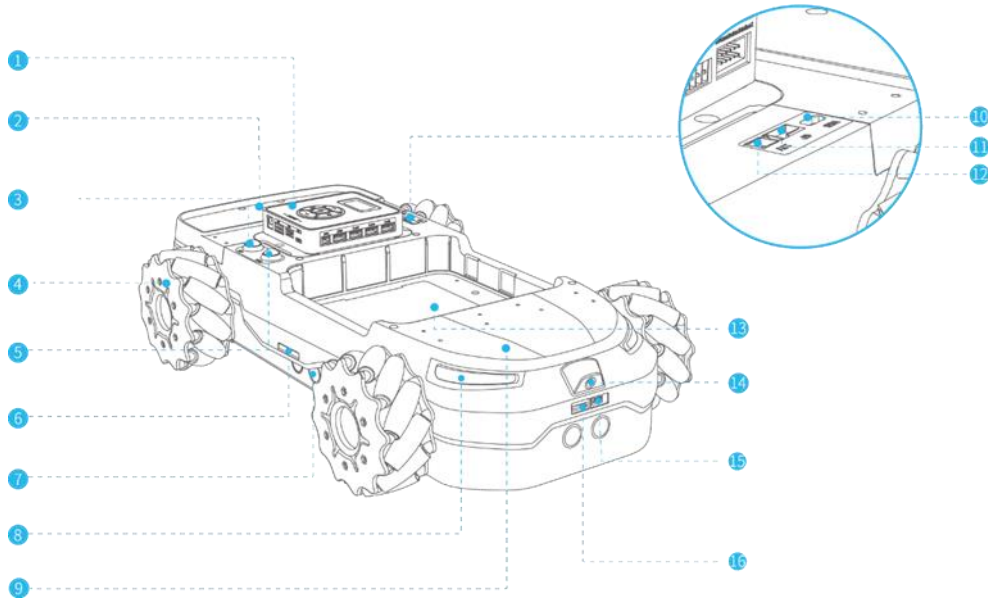

Figure 2.2 Parts of Magician Go

Table 2.1 Description on parts of Magician Go

No.	Description
1	Magic Box External controller, which has been assembled to Magician Go before delivery. It is used for logical control of Magician Go. For details, please see <i>2.2.1 Magic Box</i> .
2	Pallet Used to place objects, such as props, express boxes, etc.
3	Function key It is used to turn on or off the ultrasonic sensor (safety switch), thus realizing the obstacle avoidance. Obstacle avoidance means that when an obstacle is detected within the detection range, Magician Go stops moving to the direction of the obstacle.
4	Mecanum wheels Please see <i>2.2.3 Mecanum wheels</i> for details
5	Emergency stop switch (Stop button) In case there is an emergency when Magician Go is running, press the emergency stop switch to make Magician Go stop and lock motor movement.
6	Status indicator LEDs (two LEDs) The color, on/off status and blink reflect the current running state of Magician Go. Please see <i>2.2.4 Status indicator LEDs</i> for details.

No.	Description
7	Ultrasonic sensors (four in total) It is used to detect whether there are obstacles within the detection range. The detection range is 30cm and the scanning sector is 60°.
8	Programmable LEDs (four in total) <ul style="list-style-type: none"> • You can customize the status of the Programmable LEDs when writing programs • In other scenarios, the status of the programmable LEDs is the same as that of status indicator LEDs
9	12 holes for installing extended equipment on top cover, 8 holes for installing extended equipment on bottom cover Used to install extended equipment. The size of extension hole is M3.
10	USB interface For user extension
11	4Pin extension interface For user extension
12	12V power interface For user extension
13	Installation slot of robot arm When Magician Go is used in conjunction with Magician Lite, the installation slot of robot arm is used to place Magician Lite.
14	AI camera of Magician Go (chassis AI camera) When Magician Go is running, chassis AI camera collects and recognizes image within its field of view
15	Type C interface It is used to connect the computer and upgrade the firmware of chassis AI camera.
16	MicroSD card slot After the SD card is inserted, it can store the pictures controlled by the chassis AI camera and the trained models.

2.2.1 Magic Box

The interfaces of Magic Box are shown in Figure 2.3. Magic Box includes two 4Pin 12V power interfaces, two 10Pin communication interfaces, six 4Pin peripherals, USB interface and Type-C interface, which can expand a variety of sensor components and related accessories. Please See Table 2.2 for details.

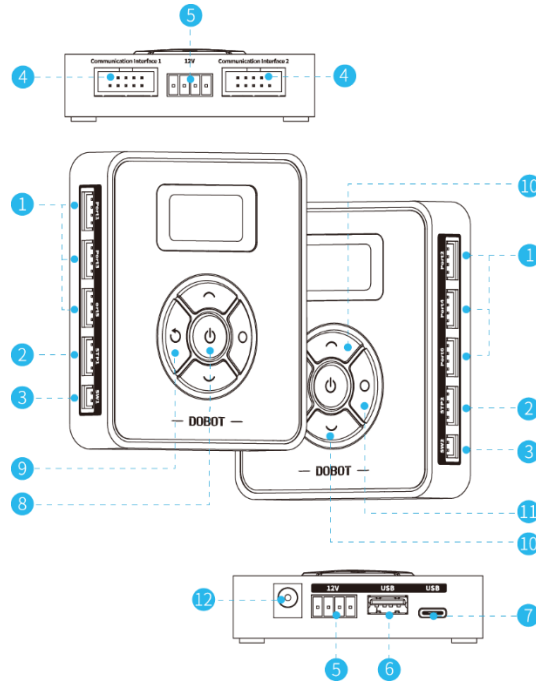

Figure 2.3 Magic Box interface

Table 2.2 Description on Magic Box interface

No.	Description
1	Peripheral: Port1~Port6. Please see Table 2.3 for details
2	DC motor/stepper motor interface
3	12V output interface
4	Communication interface, for communicating with Magician Go or Magician Lite
5	12V power interface, for providing power for Magician Lite or Magic Box
6	USB interface, for connecting joystick USB connector
7	Type C interface, to connect PC for wired control and data transmission
8	Power button, for controlling the on/off status of the system
9	Back button/Reset button
10	Function button (Up button or down button)
11	OK button or Delete button (press more than 5 seconds to delete files)
12	Power adapter interface

Table 2.3 Description on peripherals

Interface.	Description
Port 1	Connect communication cable of Magician Go camera
Port 2	Connect communication cable of Magician Lite camera
Port 3/Port 4	Used as an I2C interface, I/O interface, AD interface, PWM interface to connect AI sensor kit: knob potentiometer, light sensor, sound sensor, OLED screen, color sensor, photoelectric sensor, humiture sensor, LED module, etc.
Port 5/Port 6	Used as an I2C interface, I/O interface, or PWM interface to connect AI sensor kit: OLED screen, color sensor, photoelectric sensor, humiture sensor, and LED module

2.2.2 Power Box

Power Box is built into Magician Go, used to provide power for Magician Go, Magician Lite and Magic Box. You can know the remaining power of Power Box in the following ways. When Power Box is in low battery, please charge it in time.

1. Check through Magic Box

- Press the **Power** button of Magic Box to start up, as shown in Figure 2.4. Select **Script** in Magic Box, and press **OK**. You can check the percentage of remaining power in **Script** page, as shown in Figure 2.5.



Figure 2.4 Power Magic Box

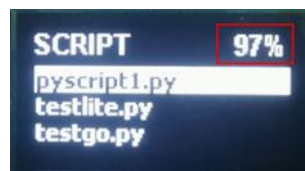

Figure 2.5 Query on Script page

- Select **Draw** in Magic Box, and press **OK** button. You can check the percentage of remaining power in **Draw** page, as shown in Figure 2.6.



Figure 2.6 Query on Draw page

- Select **Playback** in Magic Box, and press **OK** button. You can check the percentage of remaining power in **Playback** page, as shown in Figure 2.7.

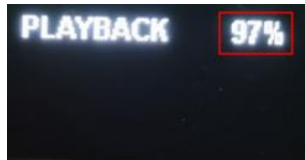
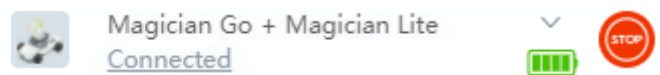

Figure 2.7 Query on Playback page

2. Check through DobotLab

- Enter <https://dobotlab.dobot.cc/> in the browser to enter the Python Lab. Choose the corresponding equipment to connect, and the battery will display in the current page.



- Or when writing a program, execute “`go.get_power_voltage()`” command. You can query the remaining power.

3. Observe the status indicator

The red color of the status LEDs indicates low power. You should charge it in time.

- Solid on: the power supply is lower than 5%, and the device is about to be off automatically
- Blink: low battery (lower than 10%)

2.2.3 Mecanum wheels

Magician Go is equipped with Mecanum wheels. Mecanum wheels are in compact structure and can move flexibly, combining forward, horizontal, diagonal and rotation movement. The Mecanum wheels are divided into two parts: two left-rotated wheels and two right-rotated wheels. The four wheels are shown in Figure 2.8.

NOTICE

The Mecanum wheels need to be used in pairs and must be installed in accordance with the specified direction in Figure 2.8 (two left-rotated wheels installed diagonally, and two right-rotated wheels installed diagonally), otherwise Magician Go will move in an abnormal direction.

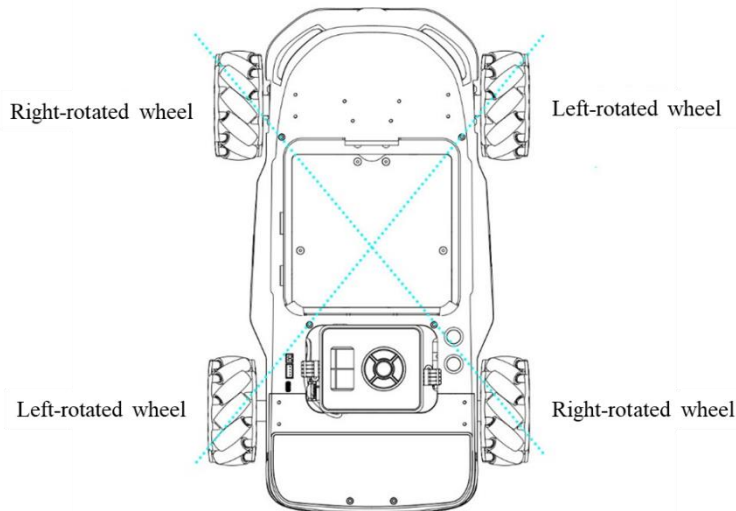

Figure 2.8 Distribution of Mecanum wheels

2.2.4 Status indicator LEDs

Magician Go has two status indicators, as shown in Figure 2.9. The color, on/off status and blink can reflect the status of Magician Go, as specifically described in Table 2.4.

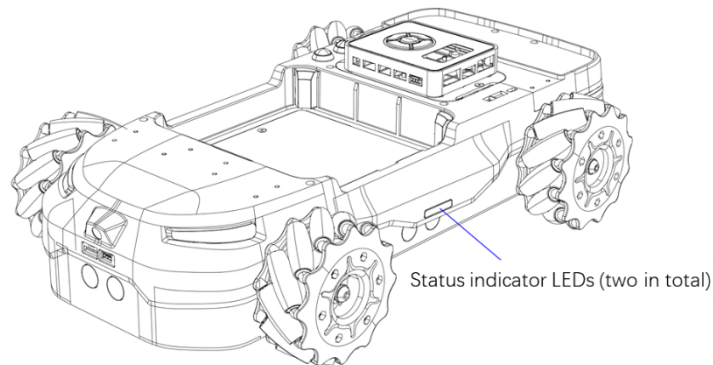









Figure 2.9 Status indicator LEDs



Table 2.4 Description on status indicator LEDs

Color	Status description
 Green	Green on: wired control mode (with four beeps) Green blink: Magician Go is charging
 Blue	Blue on: Bluetooth control mode (with four beeps)
 Purple	Purple on: remote control mode (with four beeps)
 White	White breath: idle/script control mode
 Pink	Pink on/off: Ultrasonic sensors are on/off (with two beeps)

Color	Status description
 Yellow	Yellow on: emergency switch is pressed, and Magician Go is locked Yellow blink: obstacle detected or motor blockage (with two beeps)
 Red	Red on: power below 5% (with beeps), Magician Go stops moving Red blink: power below 10% (with beeps)

When Magician Go enters alarm status, the color of status LED is yellow or red. You need to deal with alarms timely when using Magician Go. Table 2.5 lists some solutions.

Table 2.5 Alarm list

Status	Alarm description	Solutions
 Yellow on	Emergency stop alarm, triggered when you press the emergency stop button.	Press the emergency stop button again.
 Yellow blink	Alarm for detecting the obstacle or motor block. Magician Go will stop moving. The motor block alarm will automatically release after 1s..	1. Confirm whether there are obstacles 30cm away from Magician Go on four sides. If there are obstacles, control Magician Go away from the obstacles. If the alarm persists, go to Step 2. 2. Check whether Magician Go's motor shaft fixed screw is loose; check whether the motor is blocked due to external factors. Motor shaft fixed screws can be seen through the hole shown in Figure 2.10.
 Red on/blink	Low power	Charge Magician Go in time



Motor shaft fixed screw is inside Magician Go

Figure 2.10 Position of motor shaft fixed screw

2.2.5 AI camera

The chassis AI camera is designed for and built into Magician Go, as shown in Figure 2.11. The target detection algorithm is used to train the model, which is embedded in the chassis AI camera to realize road sign detection and line patrol.

- Road sign detection: automatically identify guide signs in map accessories, and give feedback on the results, which is convenient for you to simulate automatic driving scenes.
- Line patrol: automatically recognize the road line on the map

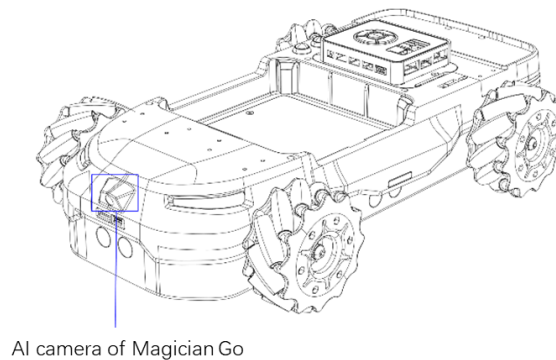

Figure 2.11 chassis AI camera

The arm AI camera is shown in Figure 2.12, which needs to be installed on Magician Lite. The target detection algorithm is used to train the model, which is embedded in the arm AI camera to realize fresh express detection, block detection and Apriltag code detection.

- Fresh express detection: automatically identify express boxes and props among map accessories, and give feedback on the results, which is convenient for you to simulate the sorting, handling and delivery.
- Block detection: automatically identify the blocks of Magician Lite.
- Apriltag detection: identify the Apriltag code and give feedback on the ID and coordinates of Apriltag code for target positioning.

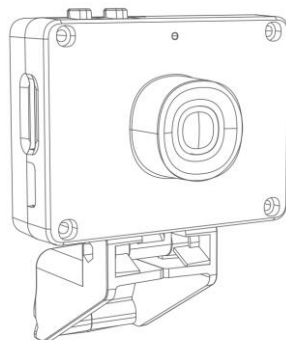

Figure 2.12 Arm AI camera

 **NOTE**

- About description on accessories of map, please see *5.1 Introduction on map and accessories* for details.

2.3 Technical specifications

2.3.1 Technical parameters

Table 2.6 Magician Go technical specifications

Specification	Description
Model	DT-AC-GO4WD-01E
Weight	5 kg
Maximum load	5 kg
Dimensions	463 mm × 289 mm × 124 mm, for details please see <i>2.3.2Dimensions</i>
Control mode	Remote control mode, Bluetooth control mode, wired control mode, script control mode, as specifically described in <i>4.1Control mode</i>
Power supply	100 V~240 V AC, 50/60 Hz
Power in	12 V/5 A DC
Control software	DobotLab (Blockly/Python programming)
Sensor	Ultrasonic sensor, gyroscope
AI camera	Chasis AI camera (built-in), arm AI camera
Wheels	Mecanum
External controller	Magic Box
Working Temperature	0°C~35°C
Main materials	ABS, PC, Aluminum alloy

Table 2.7 Magic Box technical specifications

Specification	Description
Model	DT-MB-CTR01-01E
Control chip	ARM 32-bit Cortex-M4
Main frequency	168 MHz
voltage	100 V~240 V AC, 50/60 Hz
input	12 V/5 A DC
Maximum power	60 W
Communication	USB/serial/Bluetooth

Weight	98 g
Dimensions	95 mm × 80 mm × 21.5 mm

Table 2.8 Power Box technical specifications

Specification	Description
Maximum charging voltage	12 V / 1 A DC
Input voltage/current	12 V / 5 A DC
Output voltage/maximum current	12 V / 3 A DC
Nominal capacity	2500 mAh
Rated output	27 Wh
Minimum capacity	2400 mAh
Environment temperature	0 °C ~ 35 °C
Dimensions	95 mm × 80 mm × 28.5 mm
Charging time	About 110 mins

Table 2.9 Bluetooth dongle technical specifications

Specification	Description
Dimensions	72 mm × 27.8 mm × 12.3 mm
Weight	20 g
Communication mode	USB/Bluetooth
Transmission distance	15 m (open field)

Table 2.10 Joystick technical specifications

Specification	Description
Dimensions	156 mm × 102 mm × 60 mm
Weight	190 g
Battery capacity	500 mAh

2.3.2 Dimensions

The dimension of Magician Go is shown in Figure 2.13, unit: mm.

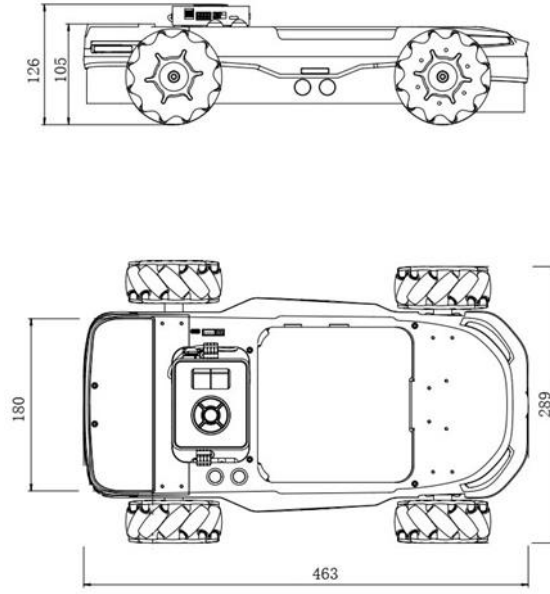

Figure 2.13 Dimensions of Magician Go

3. Wiring

3.1 Wiring of Magic Box

Magic Box has been assembled to Magician Go before delivery, and the 10Pin communications cable, 4Pin power cord and 4Pin camera communication cable have been assembled to Magician Go before delivery, as shown in Figure 3.1.



Figure 3.1 Position of Magic Box

NOTICE

Please connect cables when the device is completely powered off.

1. Wiring of Magic Box top interface

The top interface of Magic Box includes two communication interfaces: ① and ③, and a 12V power interface ②, as shown in Figure 3.2.

- Connect ① of Magic Box to 10Pin communication cable ④ for the communication between Magic Box and Magician Lite.
- Connect ③ of Magic Box to 10Pin communication cable ⑥ for the communication between Magic Box and Magician Go.
- Connect ② of Magic Box to 4Pin power cable ⑤ for providing power for Magician Lite.



Figure 3.2 Magic Box top wiring

2. Wiring of Magic Box bottom interface

The bottom interface of Magic Box includes a 12V power interface ①: as shown in Figure 3.3. Connect ① of Magic Box to 4 Pin communication cable ② to provide power for Magician Lite. The other end of ② has been connected to Magic Box.



Figure 3.3 Magic box bottom wiring

3. Wiring of Magic Box side interface

The side of Magic Box includes six peripherals: Port1~Port 6, as shown in Figure 3.4. The specific description is listed in Table 2.3.

- Connect Port1 ① of Magic Box to 4Pin camera communication cable ③ for the communication between Magic Box and chassis AI camera.
- Connect Port2 ② of Magic Box to 4Pin camera communication cable ④ for the

communication between Magic Box and arm AI camera.



Figure 3.4 Magic Box side wiring

3.2 Wiring of Magician Lite

Magician Lite needs to be purchased separately and placed in the arm installation slot of Magician Go. The arm installation slot contains a 10Pin communication cable and a 4Pin power cord for connecting the interface of Magician Lite.

NOTICE

Please connect cables when the device is completely powered off..

- Connect 12V power interface ① of Magician Lite to 4Pin camera power cable ③ of Magician Go to supply power for Magician Lite.
- Connect Communication Port ② of Magician Lite to 10Pin camera communication cable ④ for the communication between Magic Box and Magician Lite.

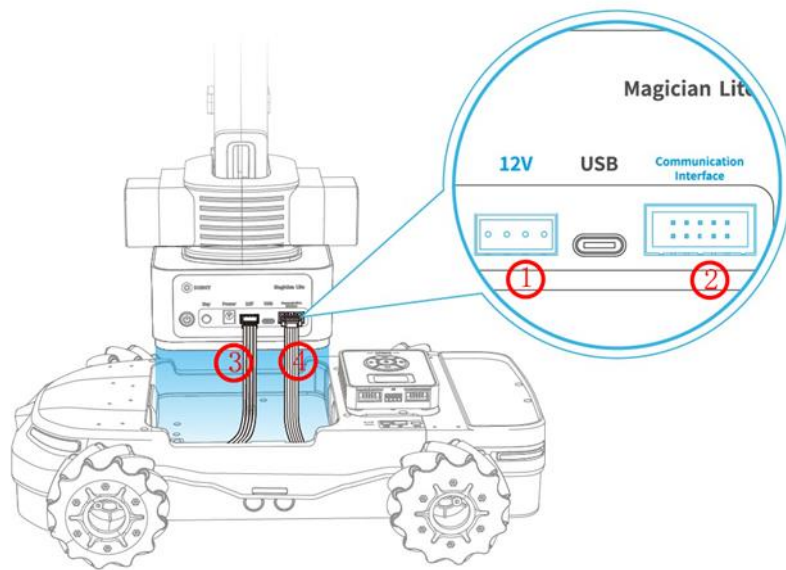

Figure 3.5 Magician Lite wiring diagram

3.3 Wiring of arm AI camera

The arm AI camera needs to be installed on Magician Lite. There is a 4Pin communication cable in the arm installation slot of Magician Go, which has been assembled to Magician Go for connecting arm AI camera.

NOTE

- Please connect cables when the device is completely powered off.

Step 1 Loosen the screws of the AI camera using a 1.5mm socket head wrench, as shown in Figure 3.6.

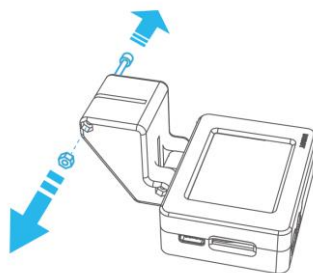

Figure 3.6 Loosen the screws

Step 2 Mount the AI camera on the servo, as shown in Figure 3.7.

Slightly open the AI camera fixture, and push into the servo of Magician Lite according to the direction in the figure. When the internal positioning hole of the AI camera fixture aligns with the screw hole of the servo, the assembly is in place.

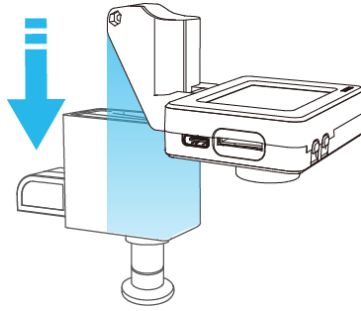

Figure 3.7 Place AI camera

Step 3 Install the screws and fix the AI camera to the servo, as shown in Figure 3.8.

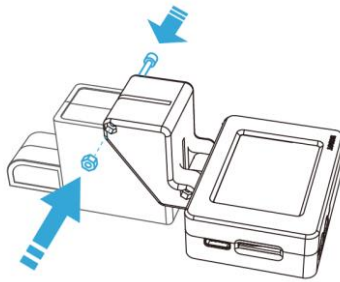

Figure 3.8 Fix AI camera

Step 4 Connect Magician Go and AI camera using the 4Pin data cable of AI camera, as shown in Figure 3.9.

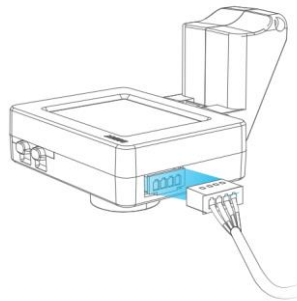

Figure 3.9 Wiring

Step 5 Adjust the angle of AI camera (range: 0° ~ 90°), as shown in Figure 3.10.

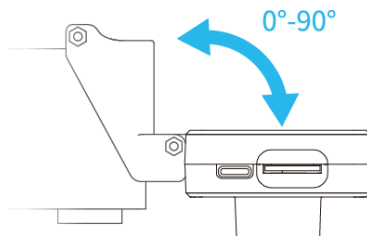

Figure 3.10 Adjust angle of AI camera

 NOTE

- To ensure the normal use of the arm AI camera, it is necessary to calibrate the camera first. For details, see *4.2.4 Arm camera calibration*.

4. Operation

4.1 Control mode

Magician Go supports four control modes: remote control mode, Bluetooth control mode, wired control mode and script control mode

4.1.1 Remote control mode

The remote control mode is to control Magician Go and Magician Lite using the joystick, so that you can quickly experience various functions of Magician Go and the Magician Lite.

Step 1 Connect the USB connector to the USB interface of Magic Box.

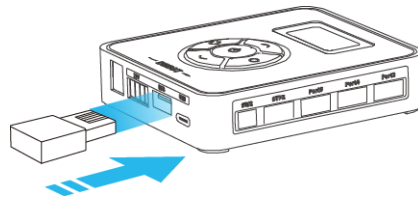

Figure 4.1 Connect USB connector

Step 2 Press the **Power** button.

The indicator LEDs of Magician Go show purple with four beeps, indicating that the USB connector has been correctly installed.

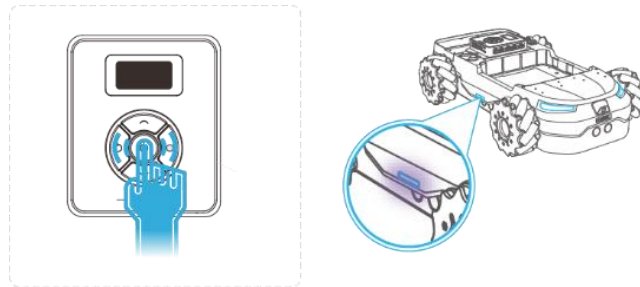

Figure 4.2 Press the Power button

Step 3 Press the **Power** button of joystick and the indicator of joystick turns red, indicating that the joystick and USB connector have been matched successfully. Now you can control Magician Go through remote control mode.

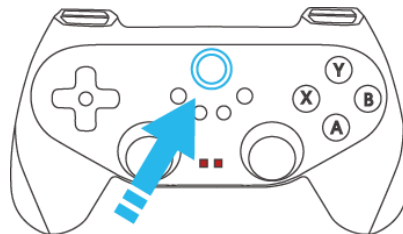

Figure 4.3 Press the Power button of joystick

Step 4 After entering the remote control mode, you can control Magician Go (and Magician

Lite) by joystick buttons. For details, please see Table 4.1.

When you cannot control Magician Go (and Magician Lite), it indicates that the current mode of the joystick is not correct. You need to adjust the joystick mode, as described below.

1. Connect the USB connector of the controller to the USB port of the PC.

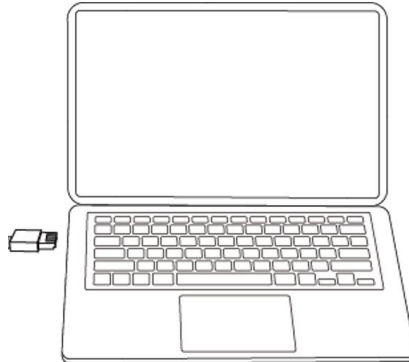

2. Click the Power button of the joystick, and the red indicator of the joystick is on. You can confirm the current joystick mode through two red indicators. The joystick has three modes, as shown below. The can control Magician Go (and The Magician Lite) when the it is in Mode 1 or Mode 2.

- Mode 1: two red indicators are on.



- Mode 2: the right red indicator is on, and the left indicator is off.



- Mode 3: the left red indicator is on, and the right indicator is off.



3. When the joystick is in Mode 3, long press the Power button. Release the button when the red indicator light of the joystick blinks. About 2s later, the red

indicator light is solid on, indicating that a mode switch is completed.

Check whether the current joystick mode is Mode 1 or Mode 2. Otherwise perform this step to adjust the joystick mode again.

Table 4.1 Description on Joystick keys

Joystick keys	Description
Power	【Magician Go & Magician Lite】 Enter/exit remote control
LT: switch to controlling Magician Go mode	
Left stick- left/ right	【Magician Go】 Turn left/ right
Right stick –forward/backward	【Magician Go】 Move forward/backward
Right stick - left/ right	【Magician Go】 Go Left/right
RT + Y	【Magician Go】 On/off the safety switch
RT + A	【Magician Go】 A beep
RT + B	【Magician Go】 Turn on the chassis rainbow effect (Click again to turn off)
LB: switch to controlling Magician Lite mode (based on joint coordinate system)	
Left stick - forward/backward	【Magician Lite】 Control joint coordinate system J1
Left stick - left/ right	【Magician Lite】 Control joint coordinate system J2
Right stick - forward/backward	【Magician Lite】 Control joint coordinate system J3
Right stick - left/ right	【Magician Lite】 Control joint coordinate system J4
RB: switch to controlling Magician Lite mode ((based on Cartesian coordinate system)	
Left stick - forward/backward	【Magician Lite】 Control Cartesian coordinates x axis
Left stick - left/ right	【Magician Lite】 Control Cartesian coordinates y axis
Right stick - forward/backward	【Magician Lite】 Control Cartesian coordinates z axis
Right stick - left/ right	【Magician Lite】 Control Cartesian coordinates R axis
Back	【Magician Lite】 Home

Joystick keys	Description
X	【Magician Lite】 Control pumping up/gripper (gripping)/suction cup (gripping)
Y	【Magician Lite】 pumping down/gripper (releasing)/suction cup (releasing)
B	【Magician Lite】 Close the pump/Disable the gripper

4.1.2 Bluetooth control mode

The Bluetooth control mode is used to control Magician Go and Magician Lite on DobotLab software platform.

- Enable DobotLab to obtain real-time running parameters of Magician Go and Magician Lite.
- Support real-time control of Magician Go and Magician Lite on DobotLab using blockly programming, Python programming and control panel.
- Support online debugging and can realize the interaction between AI functions and equipment, such as using AI voice recognition to control car movement.

NOTE

Magician Go needs to be controlled within the range of Bluetooth connection. Please avoid accidental disconnection, and ensure that there is no obstacle between Magician Go and Bluetooth dongle.

Step 1 Connect Bluetooth dongle to the USB interface of the computer, as shown in Figure 4.4.

The indicator of Bluetooth dongle blinks quickly (or slowly), and it searches for Magic Box automatically.

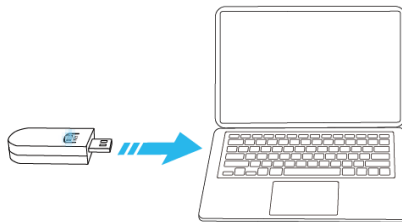

Figure 4.4 Install Bluetooth dongle

NOTE

For the technical specifications of Bluetooth dongle, please see

Table 2.9.

Step 2 Press the Power button of Magic Box, as shown in Figure 4.5.



Figure 4.5 Power Magic Box

- The indicator of the Bluetooth dongle shows blue when the Bluetooth dongle is automatically paired with Magic Box. Then go to Step 3.
- The indicator of Bluetooth dongle blinks at short intervals (or long intervals) when no Magic Box is found. Hold down the KEY of the Bluetooth dongle for three seconds until the indicator changes, and the Bluetooth dongle clears the previous device connection information. The indicator of the Bluetooth dongle blinks slowly when the search for Magic Box is underway. Now the Bluetooth dongle will search all Magic boxes in the space and match with the Magic Box with the strongest signal. If the Bluetooth dongle is successfully matched with Magic Box, the indicator of the Bluetooth dongle shows blue, then go to Step 3.

Step 3 Short press “KEY” of Bluetooth dongle.

The corresponding Magic Box will sound beeps, which is convenient for you to find the corresponding connected device.

Step 4 Enter <https://dobotlab.dobot.cc/> in your browser. Enter DobotLab, as shown in Figure 4.6.

After connecting the corresponding device, the status indicator of Magician Go shows blue. You can control Magician Go (and Magician Lite) using block programming, Python programming and control panel.

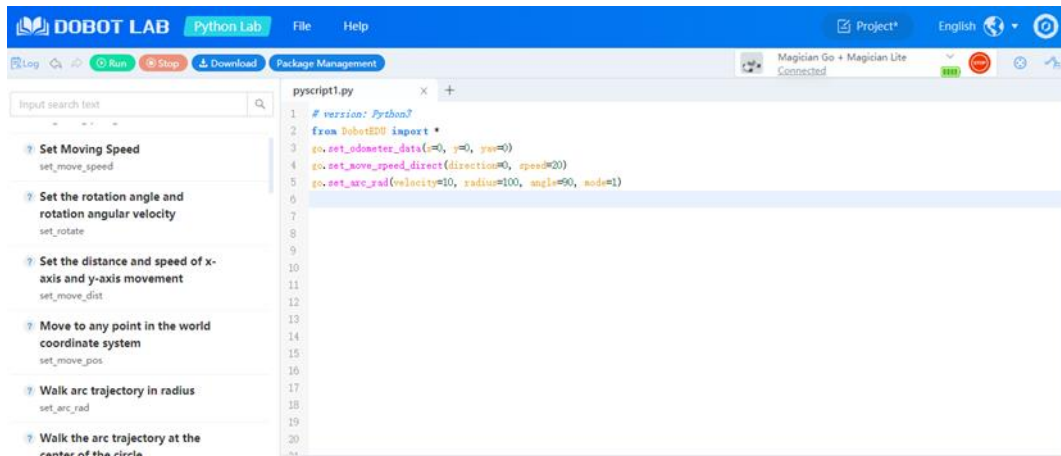

Figure 4.6 Enter LobotLab

NOTE

For the instruction on DobotLab, please see *4.2 DobotLab operation*.

4.1.3 Wired control mode

Wired control mode is used to control Magician Go and Magician Lite on DobotLab software platform through wired connection.

- Enable DobotLab to obtain real-time running parameters of Magician Go and Magician Lite.
- Support real-time control of Magician Go and Magician Lite on DobotLab using block programming, Python programming and control panel.
- Support downloading programme-generated scripts from DobotLab to Magic Box (Bluetooth control mode does not support this function).
- Supports software upgrade of DobotLink (Bluetooth control mode does not support this function).

NOTE

In wired control mode, it is suggested to use the bracket to suspend Magician Go, so that the wheel does not contact the ground to avoid the abnormal line connection when controlling Magician Go.

Step 1 Connect Magic Box to the USB interface of computer using USB cable, as shown in Figure 4.7.

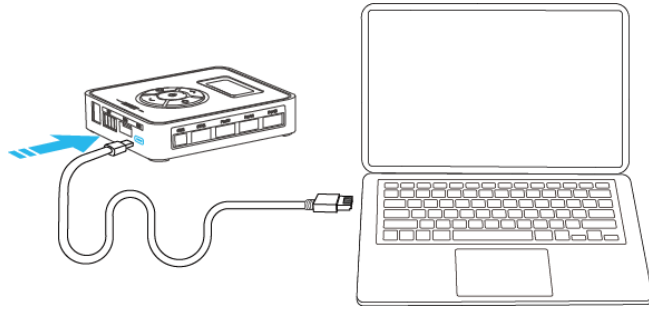

Figure 4.7 Connect device with USB

Step 2 Press the **Power** button, as shown in Figure 4.8.



Figure 4.8 Power Magic Box

Step 3 Enter DobotLab (<https://dobotlab.dobot.cc/>), as shown in Figure 4.9. Select corresponding device for connection, and the status LEDs of Magician Go show green. Now you can control Magician Go (and Magician Lite) by blockly programming, Python programming and control panel

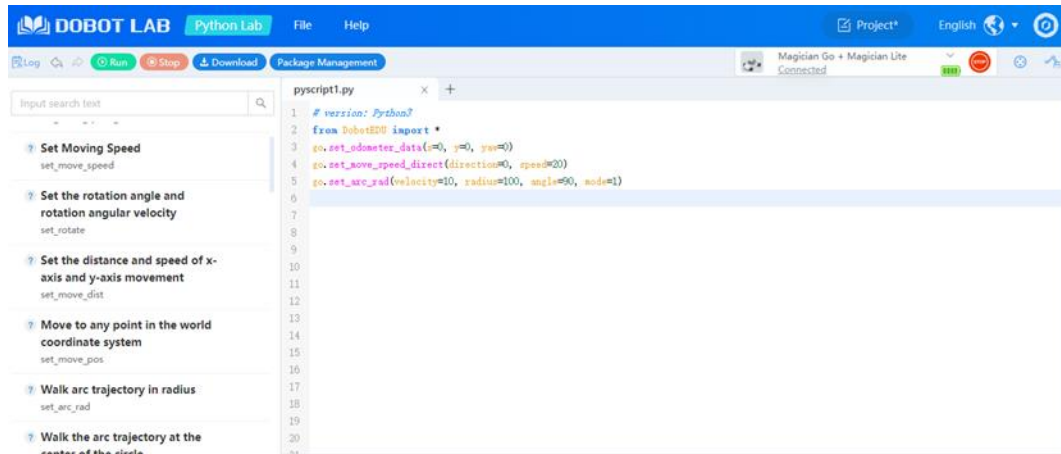

Figure 4.9 Enter Dobotlab

NOTE

For the instruction on DobotLab, please see *4.2 DobotLab operation*.

4.1.4 Script control mode

In wired control mode of Magician Go, you can download scripts generated through programming- in DobotLab to Magic Box. You can controlled Magician Go and Magician Lite by running scripts in Magic Box in script control mode.

 **NOTE**

- Downloading script from DobotLab to Magic Box is only supported in wired control mode.
- The script control mode has the highest priority. Other control modes cannot be directly accessed. If you want to switch to other control modes, exit the script control mode first.
- In script control mode, Bluetooth connection or wired connection can still be maintained, but only the function that DobotLab accesses the real-time parameters of Magician Go and Magician Lite is supported.

Step 1 Press the **Power** button, as shown in Figure 4.10.



Figure 4.10 Power Magic Box

Step 2 Select “Script” in Magic Box, and press **OK** button to enter Script page. Select a script.

 **NOTE**

apiscript.py and betagoscript.py in Script are library files that support offline running of script. Do not delete them; otherwise, scripts cannot run properly.

Step 3 Click **OK** button to run the script, as shown in Figure 4.11.

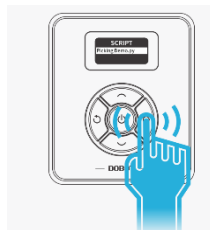

Figure 4.11 Run the script

4.2 DobotLab operation

4.2.1 Introduction on DobotLab

DobotLab (website: <https://dobotlab.dobot.cc/>) is an integrated software platform specially designed for artificial intelligence (AI) education. DobotLab has two core programming modules, namely DobotBlock Lab and Python Lab. The main interface is shown in Figure 4.12.

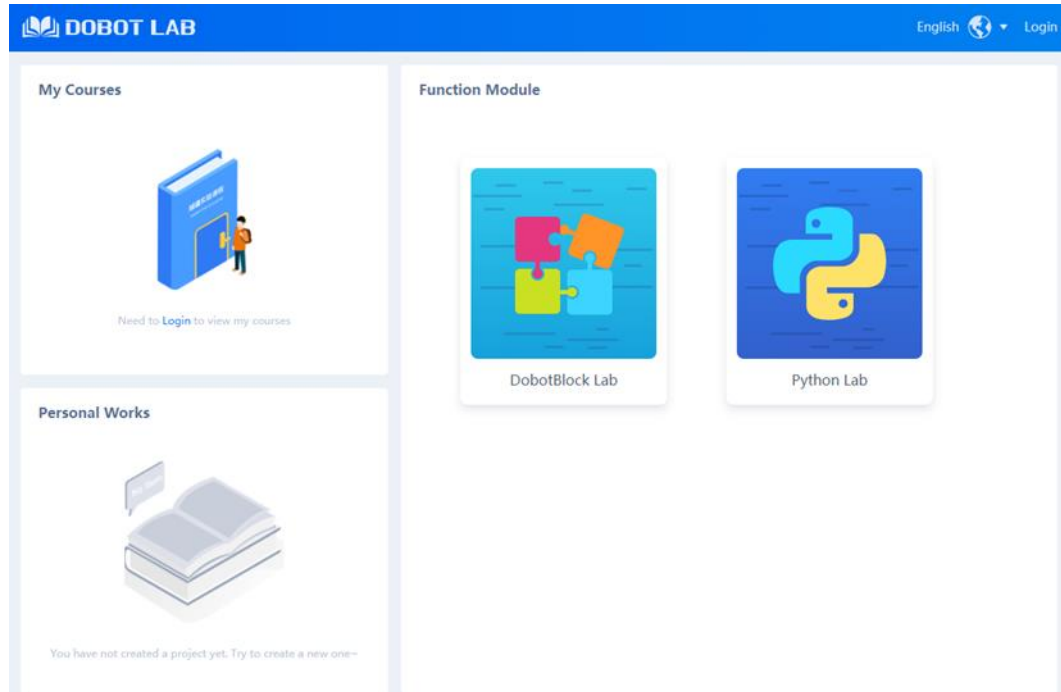

Figure 4.12 DobotLab main interface

NOTE

- Enter <https://dobotlab.dobot.cc/> in your browser to enter DobotLab. It is recommended to use Google Chrome.
- Please log in when using DobotLab to experience more functions.
- Magician Go can be connected with DobotLab only in Bluetooth control mode or wired control mode. Before using DobotLab, please first enter Bluetooth control mode or wired control mode according to the steps in *4.1.2 Bluetooth control mode* or *4.1.3 Wired control mode*.
- As DobotLink is the driver software of DobotLab, you need to install and run DobotLink before using DobotLab. When DobotLab is started, if DobotLink is not installed or started, the “DobotLink is not started” window will be displayed. Then you need to select **Download DobotLink** or **Start** as required.

4.2.2 Instruction on DobotBlock Lab

The main interface of DobotBlock Lab is shown in Figure 4.13, and the specific description is listed in Table 4.2.

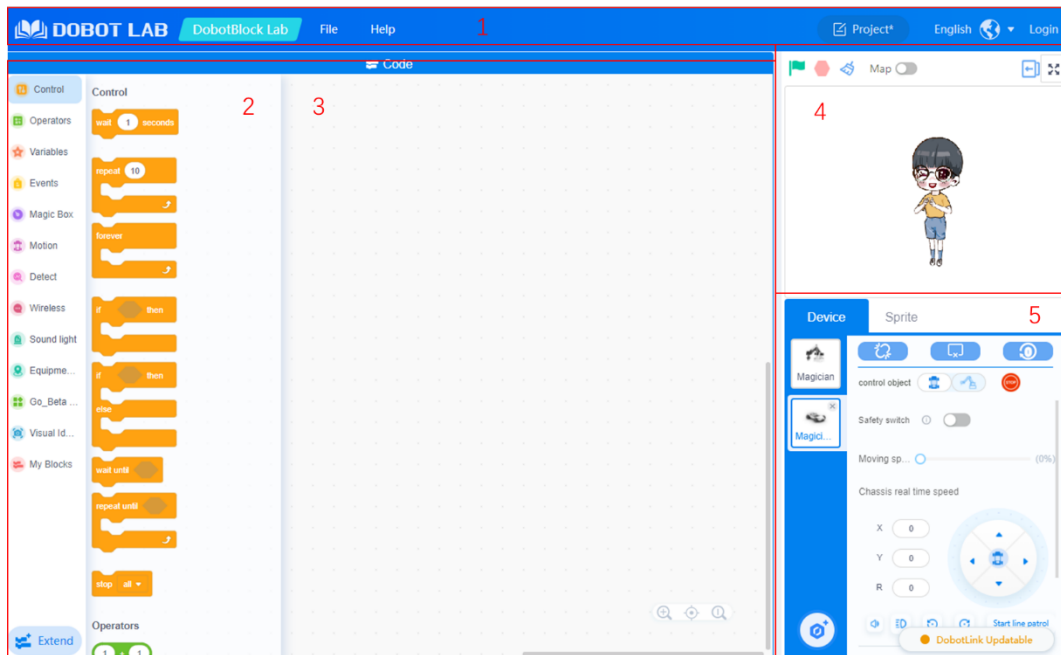



Figure 4.13 DobotBlock Lab main interface

Table 4.2 Description on DobotBlock Lab main interface

No.	Function	Description
1	Menu	<p> DOBOT LAB: Click to return to the main page of DobotLab</p> <p> File: This menu includes functions such as new, open, save, upload from local, etc.</p>
2	Block area	Provide programming blocks. You can find the required blocks according to the classification and color
3	Code area	You can write a program by dragging blocks to the area
4	Display area	Display device appearance
5	Control area	Connection control, jogging control, speed control, etc.

Prerequisites

- Magician Go has entered Bluetooth control mode and wired control mode.
- You have logged in DobotLab.

Procedure

Step 1 Click  in the main page of DobotLab to enter DobotBlock Lab.

Step 2 Click , as shown in Figure 4.14. Select **Magician Go** or **Magician Go +**

Magician Lite on “Choose a Device” page, as shown in Figure 4.15.



Figure 4.14 Control area

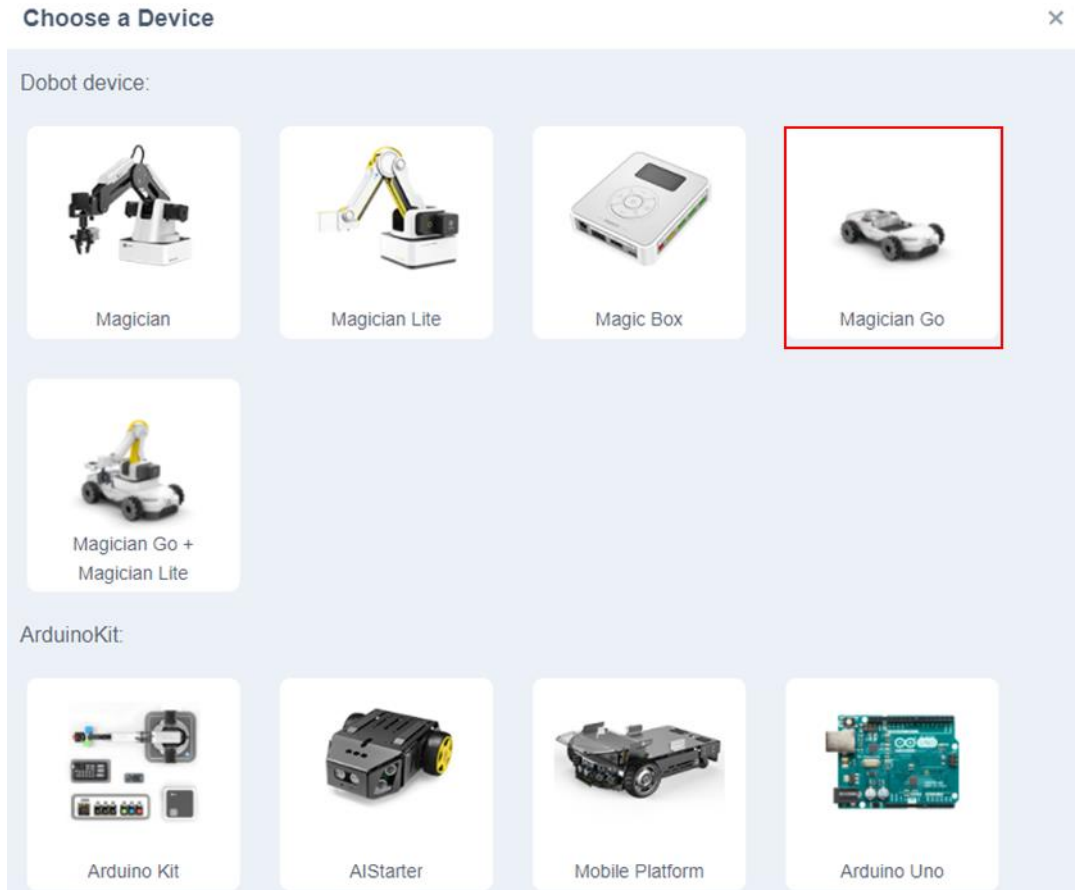

Figure 4.15 Choose a device

Step 3 Click  on Block area.

Enter “Choose an Extension” page, as shown in Figure 4.16. Select Magician Lite. Add the commands of Magician Lite to Block area.

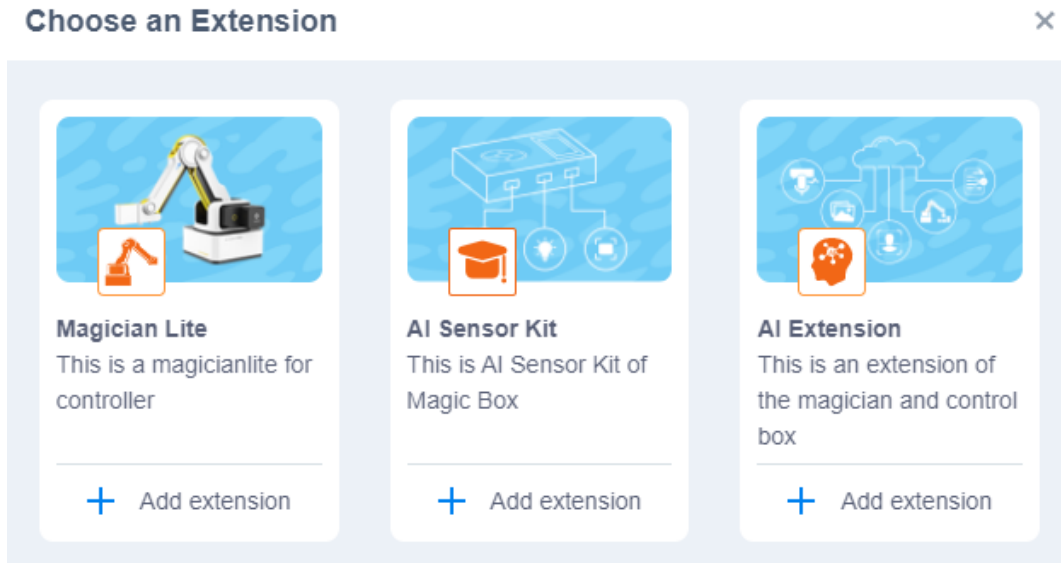

Figure 4.16 Choose an extension

Step 4 Select Magician Go on Control area, then click , as shown in Figure 4.17.



Figure 4.17 Connect the device

Step 5 Click “Connect”, as shown in Figure 4.18.

Figure 4.19 shows successful connection of Magician Go and DobotLab.

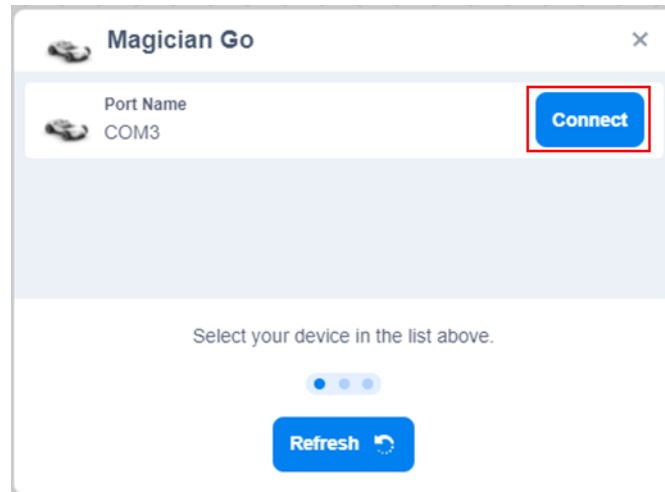

Figure 4.18 Connect Magician Go and DobotLab

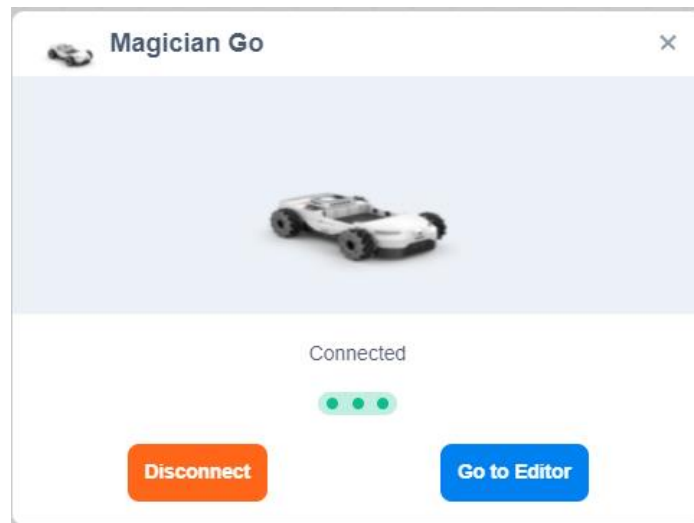

Figure 4.19 Successful connected

Step 6 After connecting Magician Go and DobotLab, you can program on block area, as shown in Figure 4.20.

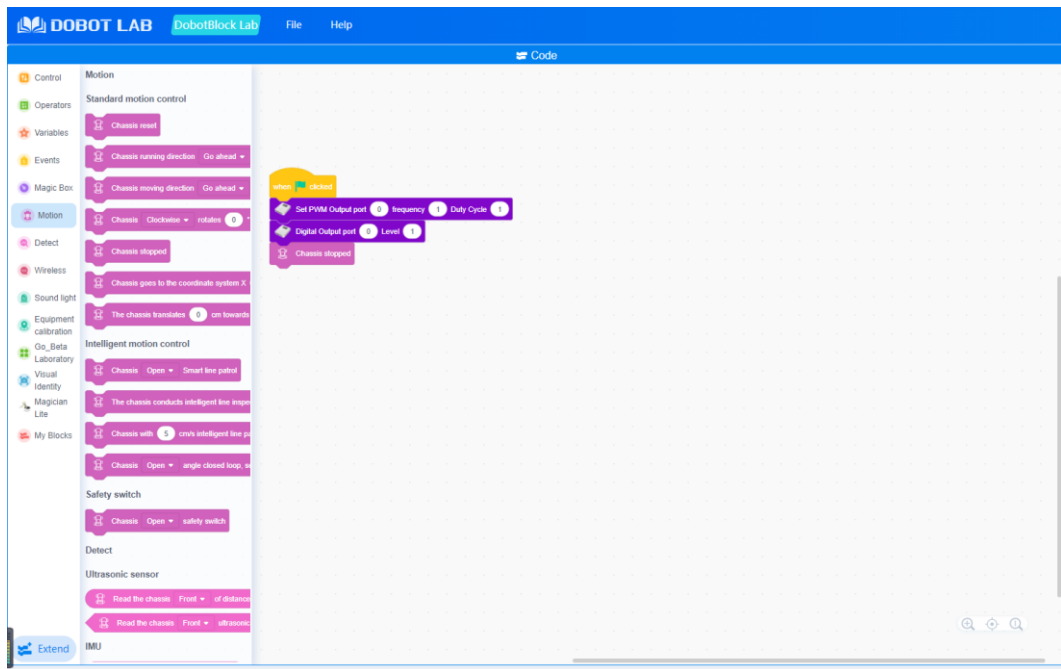



Figure 4.20 Blockly programming

- Set parameters corresponding to each block based on actual programming requirements.
- The program written with blocks requires triggering conditions to run. Therefore, you need to select a command from the event block as the triggering condition, as shown in Figure 4.21. For example,  means the program starts to run once you click .

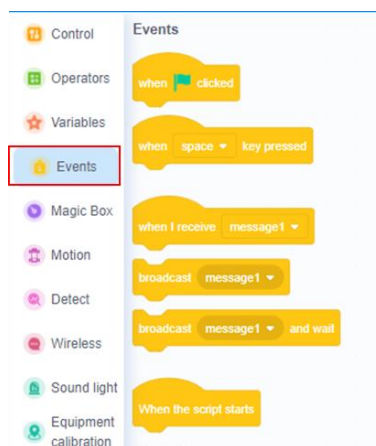

Figure 4.21 Event block

4.2.3 Instruction on Python Lab

The main interface of Python Lab is shown in Figure 4.22. The specific description is listed in Table 4.3.

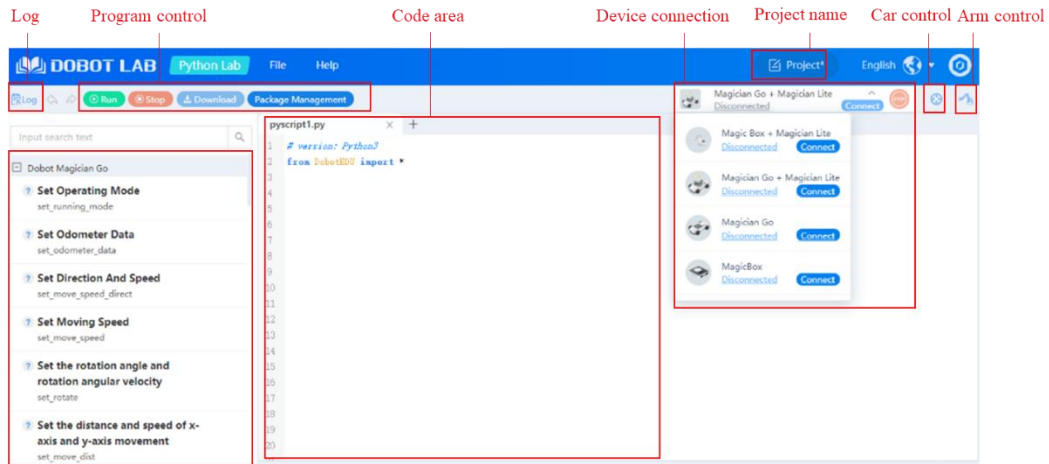

Figure 4.22 Python Lab main interface

Table 4.3 Description on Python Lab main interface

Function	Description
Log	Display alarm information
Program control button	<ul style="list-style-type: none"> 运行 Start to run the program in the code area 停止 Stop running program 下载 Download the current program in the code area to Magic Box 库管理 Install the Python extension library, after which you can call the library functions in the extension library
File	Support functions including new, open, save, upload from local
Help	Provide help documents
Code	Area for writing programs
Device connection	Select the target device and establish a communication connection with the device
Arm control	Control Magician Lite, see Table 4.4 for details
Chassis control	Control Magician Go, see Table 4.5 for details
Command list	Provide programming commands. You can double click commands to display code in code area

Figure 4.23 shows the arm control panel. Table 4.4 lists its specific description.

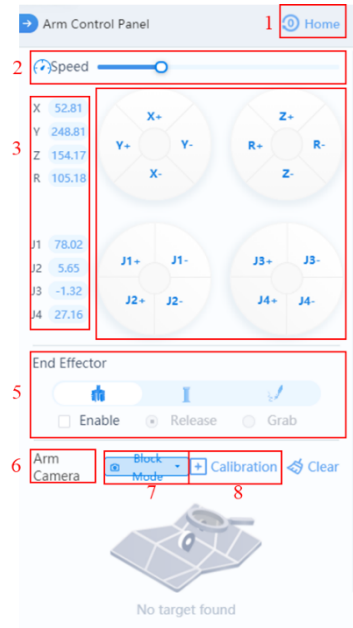

Figure 4.23 Arm control panel

Table 4.4 Description on arm control panel





No.	Function	Description
1	Home	Move Magician Lite to the home point
2	Speed	Speed of Magician Lite in jogging movement
3	Coordinates	Coordinates of Magician Lite in joint coordinate system and Cartesian coordinate system
3	Jogging control	Control Magician Lite in joint coordinate system and Cartesian coordinate system
4	End effector	Used to select an end effector (gripper or suction cup) and control the end effector to work in the enabled state
6	Arm camera	View the target type obtained by the arm AI camera
7	Block detection	Select the detection type of the arm AI camera Click “Building block Detection” and select a detection mode from the Road sign Mode, Apriltag Mode and Goods Mode displayed in the drop-down list (the am AI camera identifies the target according to the detection mode)
8	Calibration	Calibrate the arm AI camera to determine the coordinate conversion relationship between the visual coordinate system and arm coordinate system. For details, please see <i>4.2.4Arm camera calibration</i>

The chassis control panel is shown in Figure 4.24, and the specific description is listed in Table 4.5.



Figure 4.24 Car control panel

Table 4.5 Description on car control panel

No.	Function	Description
1	Reset	Empty the coordinates of the chassis and use the current position as the origin of the coordinates
2	Safety switch	Used to control the on/off status of ultrasonic sensor, so as to realize obstacle avoidance
3	Chassis real-time coordinates	X-coordinate, Y-coordinate and R-angle of the current position of Magician Go (relative to the coordinate origin after reset)
4	Set moving speed	Moving speed of Magician Go in jogging movement
5	Chassis real-time speed	Speed of Magician Go on the X, Y and R axes
6	Jogging button	Used to control the up, down, left, right and specific Angle moving of Magician Go
7		Magician Go rotates counterclockwise
8		Magician Go rotates clockwise
9		Whistle
10		Flash
11	Automatic line patrol	Used to start automatic line tracing of Magician Go
12	Chassis AI camera	View the target type obtained by chassis AI camera and the current position of Magician Go

Prerequisites

- Magician Go has entered Bluetooth control mode or wired control mode.
- You have logged in DobotLab.

Procedure

- Step 1** Click  on DobotLab main page to enter Python Lab.
- Step 2** Click the drop-down list of device connection panel, as shown in Figure 4.25. Choose corresponding device and click **Connect** button.

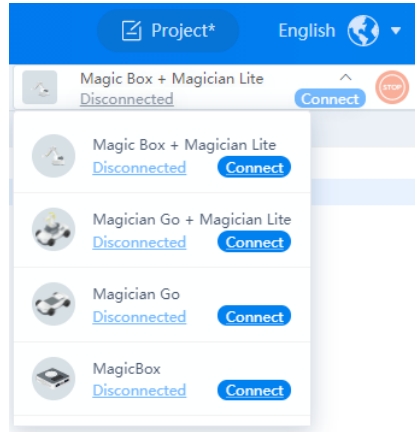

Figure 4.25 Device connection

Take Magician Go as an example. Choose “Magician Go” and click **Connect**. DobotLab is connected to Magician Go successfully, as shown in Figure 4.26. After installing the arm in place, choose “Magician Go + Magician Lite” to connect.

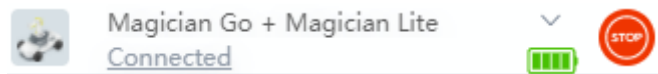



Figure 4.26 Device is connected

- Step 3** After connecting Magician Go and DobotLab, you can start to write programs. Double click commands in command list. Then the code will display on code area. You can modify the parameters according to actual use.
- Step 4** Click  to run the current code.

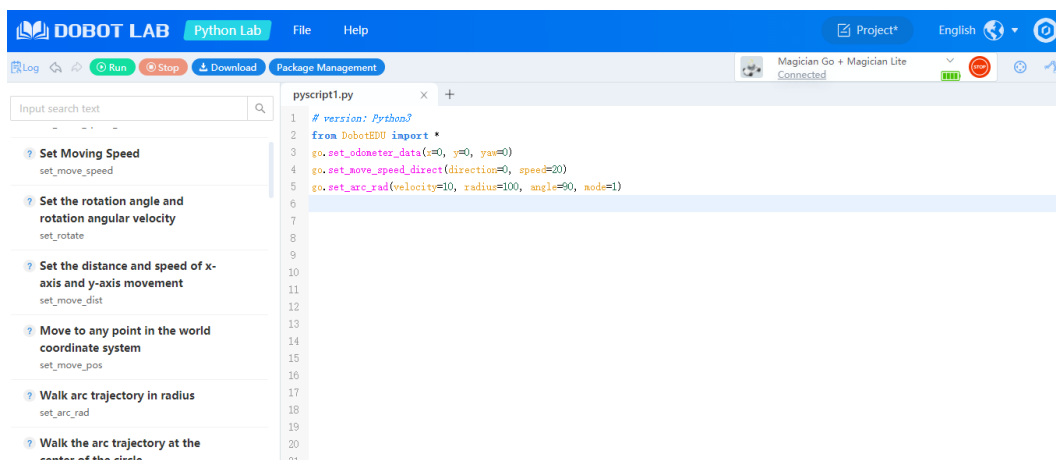

Figure 4.27 Start programming

Step 5 (Optional) Click  to download the script to Magic Box.

 **NOTE**

- The script can be downloaded from DobotLab to Magic Box only in wired control mode.
- When you download the current program, two library files `apiscript.py` and `betagascript.py` are also downloaded to support the offline running of script.

4.2.4 Arm camera calibration

In order to ensure the normal use of the arm AI camera, you need to calibrate the camera first to determine the coordinate conversion relationship between the visual coordinate system and the arm coordinate system.

Prerequisites

- Place Magician Lite in the arm installation slot of Magician Go and connect the wires. For wiring of Magician Lite, please see *3.2Wiring of Magician Lite*.
- For steps of installing the arm AI camera, please see *3.3Wiring of arm AI camera*.
- Magician Go and Magician Lite have successfully entered Bluetooth control mode or wired control mode.
- You have logged in DobotLab.

Procedure

Step 1 The calibration board is shown in Figure 4.28. Place it on the pallet of Magician Go following the direction in Figure 4.29.

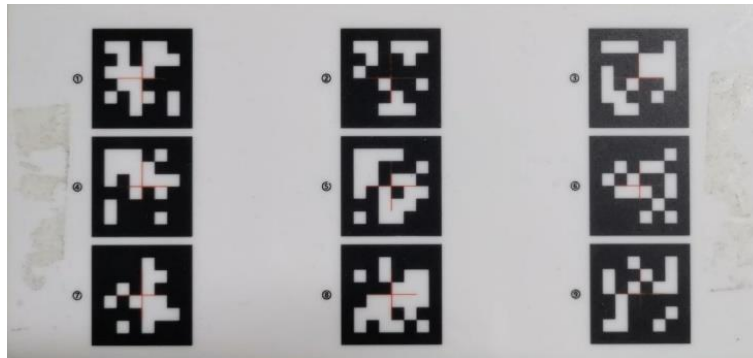

Figure 4.28 Calibration board

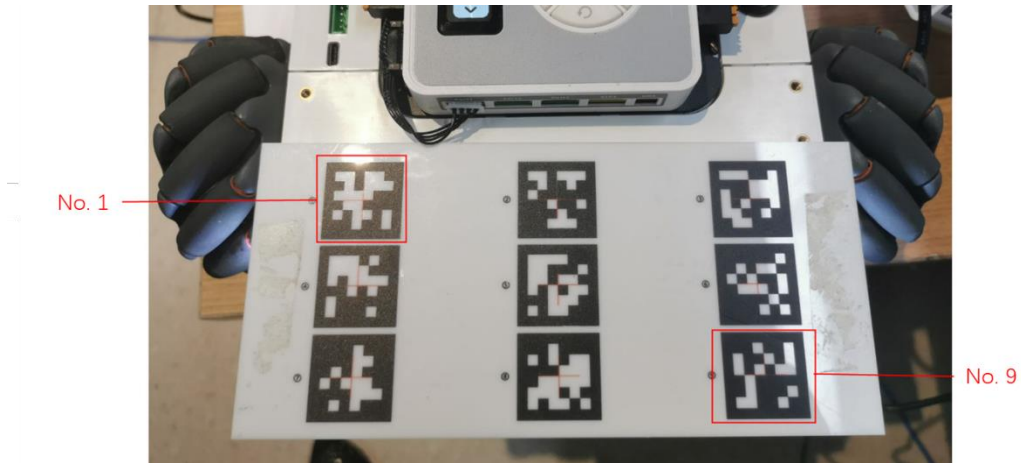

Figure 4.29 Place calibration board on pallet of Magician Go

Step 2 Click **Calibration** on the arm control panel of Python Lab, as shown in Figure 4.30. Or click **Calibration** in the Calibration block of DobotBlock Lab, as shown in Figure 4.31.

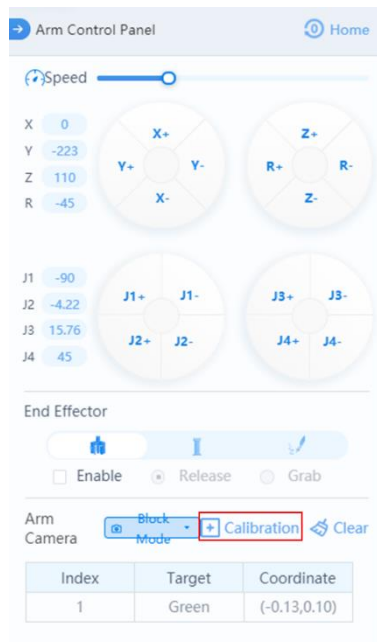

Figure 4.30 Click Calibration

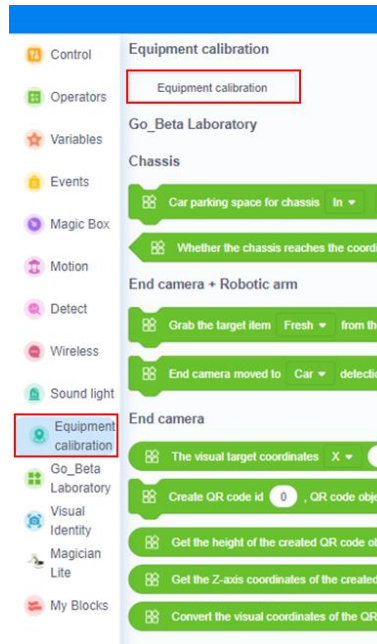

Figure 4.31 Equipment calibration block

Enter the calibration board scanning page, and when all the QR codes (9 in total) on the calibration board are detected, the calibration can be started, as shown in Figure 4.32.

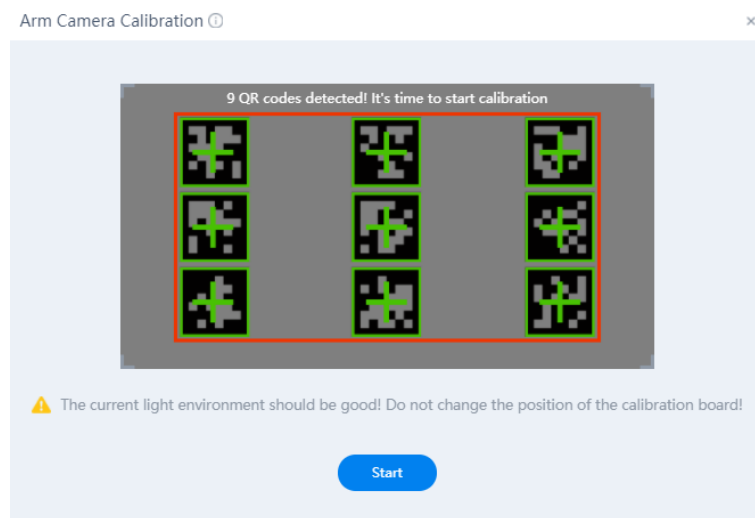

Figure 4.32 Scan calibration board

NOTE

Place the calibration board correctly on the pallet of Magician Go. Start calibration if all the QR codes on the calibration board (a total of 9) can be scanned through the AI camera. Otherwise, you need to adjust the position of calibration board.

Step 3 Click Start.

Enter “Arm Camera Calibration” page.

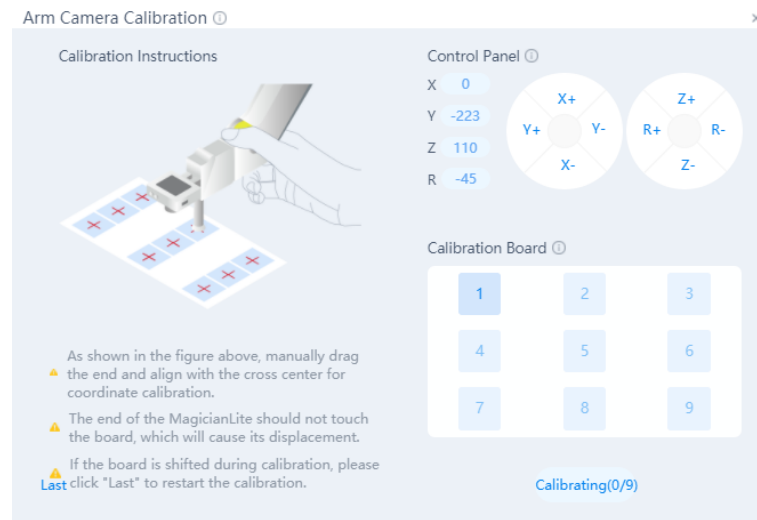

Figure 4.33 Arm camera calibration

Step 4 Move Magician Lite using the **Control Panel** on the calibration page of the arm camera to align the suction cup center of Magician Lite with the cross center of No. 1 QR code on the calibration board, as shown in Figure 4.34.

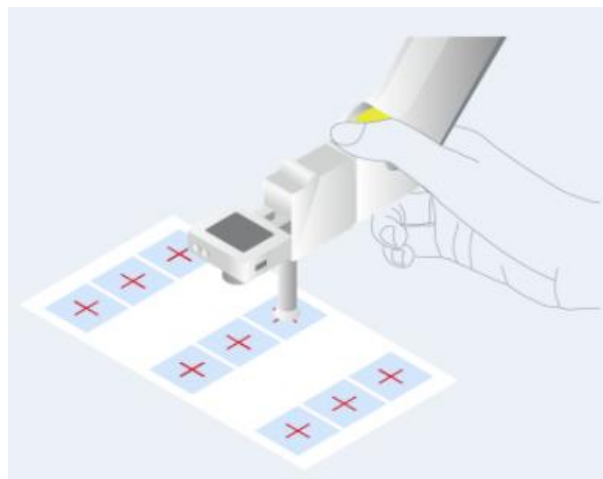

Figure 4.34 Align the suction cup center of Magician Lite with the cross center of QR code

Step 5 Click “1” in Calibration Board on the page, as shown below.
Record the current coordinates of Magician Lite. The first QR code calibration is completed.

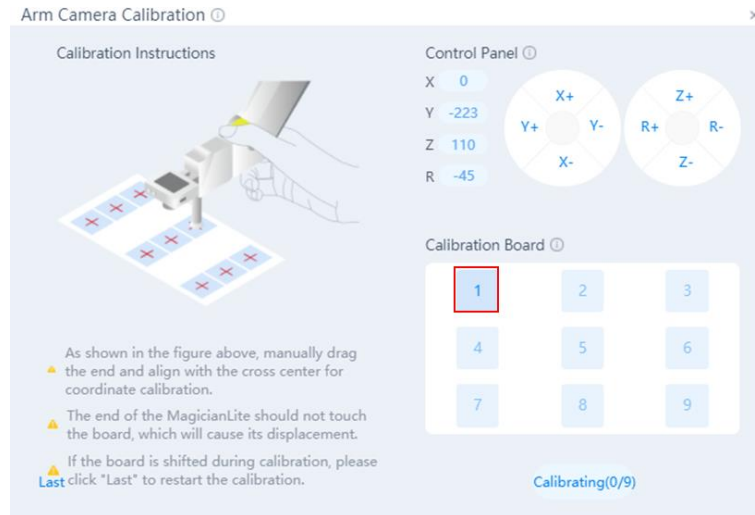

Figure 4.35 Calibrate No.1 QR code

NOTE

During the calibration process, the end should be as close to the calibration board as possible, but should not touch the calibration board, which will cause its displacement. Otherwise, click “Last” to restart the calibration.

- Step 6** Complete the calibration of the 2nd to 9th QR code according to Step 4 and Step 5. When pointing at the number on Calibration Board, you can click the delete button to re-calibrate a QR code alone.



Figure 4.36 Calibration is finished

NOTE

The sequence of the 9 QR codes on the calibration board is in z-shaped distribution. During the calibration process, you need to calibrate in accordance with the numbering sequence (From No.1 to No.9).

- Step 7** Click **Finish**.

- Figure 4.37 shows that the calibration is successful.

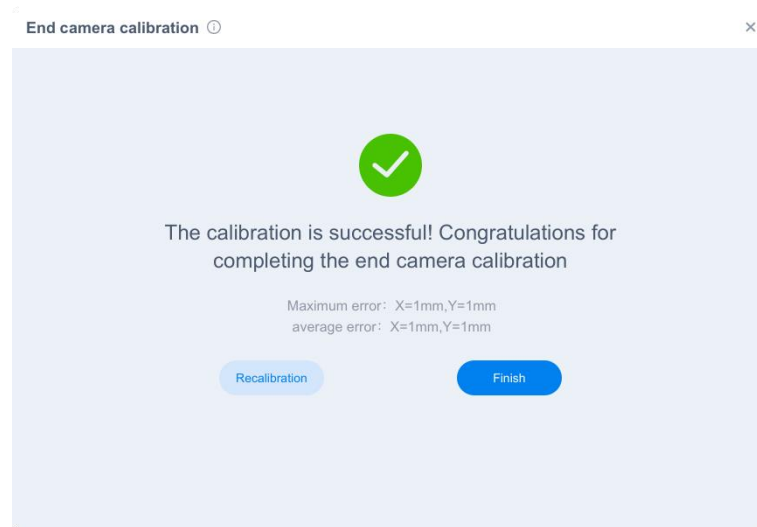

Figure 4.37 Calibration is successful

- Figure 4.38 shows that you failed to calibrate. You need to recalibrate the camera.

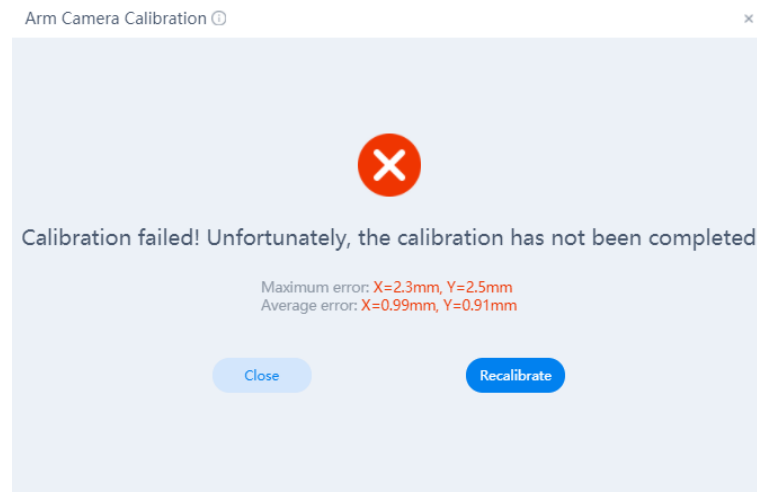

Figure 4.38 Failed to be calibrated

5. About Map

5.1 Introduction on map and accessories

The map, with the theme of automatic driving in the future robot city, mainly includes five areas: starting point, residence, supermarket, Go's home and intelligent warehouse. Its size is 328 cm × 235 cm, as shown in Figure 5.1. Using maps with accessories, you can create a variety of application scenarios. Magician Go and Magician Lite can realize road identification, route selection, material sorting and handling in different scenarios. Magician Go identifies lane center line, zebra crossing, guide signs through chassis AI camera, and identifies props through arm AI camera.

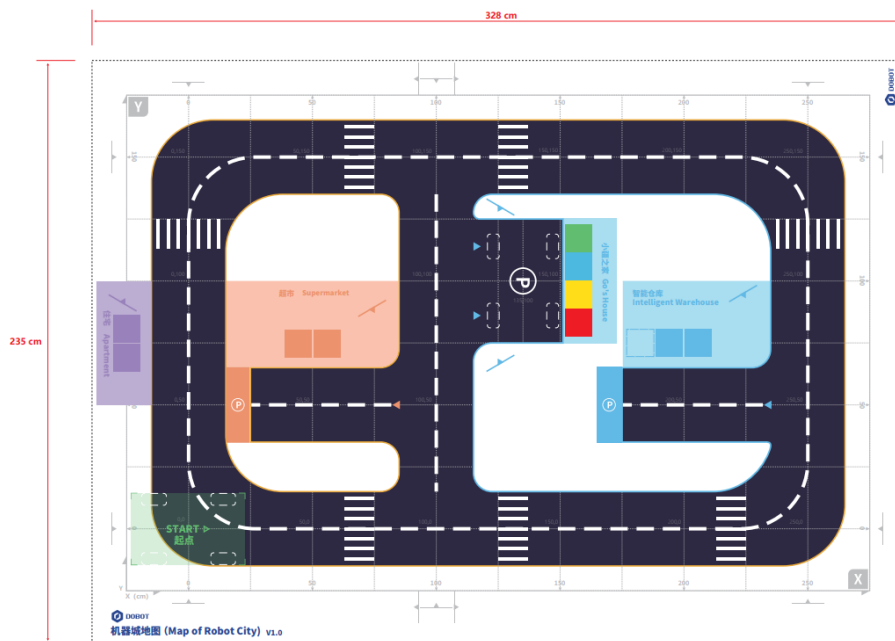



Figure 5.1 Map of robot city

The map is equipped with a variety of accessories, including guide signs, express boxes, placing boxes and props.

NOTE

- Map accessories must be placed in the specified position on the map
- Guide signs must be placed in the same direction as  (sharp corner), as shown in Figure 5.2.

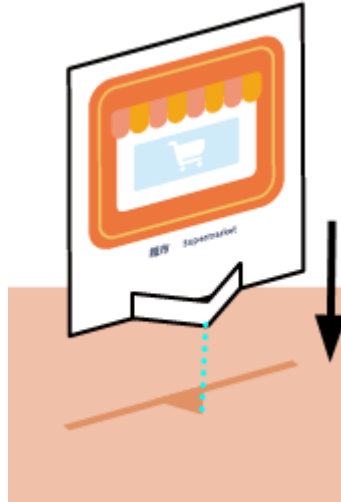







Figure 5.2 Placing of guide sign

1. The guide signs include road signs, stopping sign and area sign, as described below.

- Road signs

The road signs are shown in Table 5.1. They must be placed according to Figure 5.3.

Table 5.1 Road signs

Icon	Description
	Turn left
	Turn right
	U-turn
	Turn left or go straight
	Turn right or go straight
	T-junction

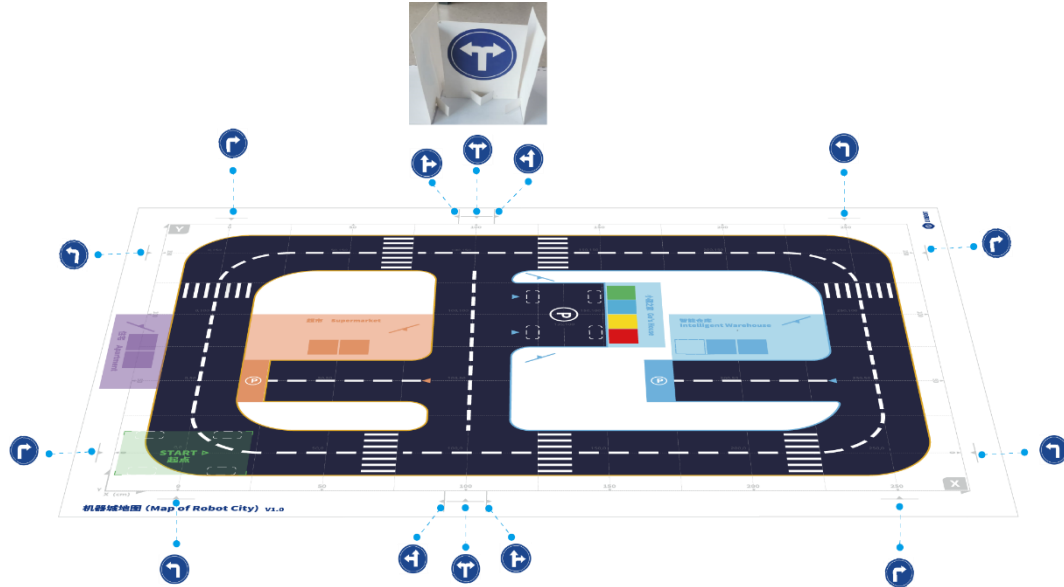





Figure 5.3 Position of road signs

- Stopping signs

Stopping signs are shown in Table 5.2.

Table 5.2 Stopping sign

Icon	Description
	Stop
	STOP

 must be placed following the specified position in Figure 5.4.  can be placed according to your actual need.

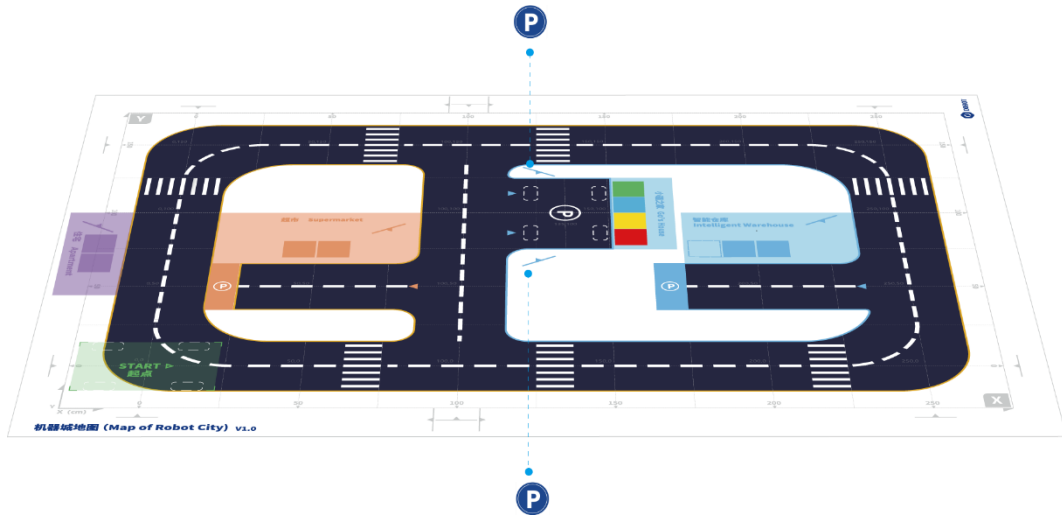





Figure 5.4 Position of “stop” road sign

- Area signs

The area signs are shown in Table 5.3. They must be placed according to Figure 5.5.

Table 5.3 Area sign

Icon	Description
	Supermarket
	Intelligent warehouse
	Residence

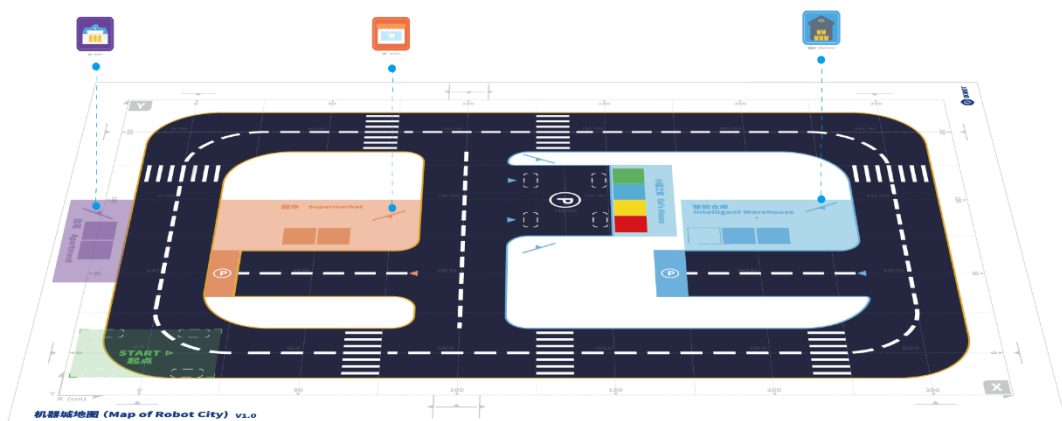

Figure 5.5 Position of area sign

2. Placing boxes include intelligent express cabinet, intelligent warehouse shelf and supermarket placing boxes (goods entry, goods delivery), as shown in Table 5.4. Please place the boxes according to the position in Figure 5.6.

Table 5.4 Placing boxes

Icon	Description
	Intelligent express cabinet
	Intelligent warehouse shelf
	Supermarket placing box (for goods entry)
	Supermarket placing box (for goods delivery)

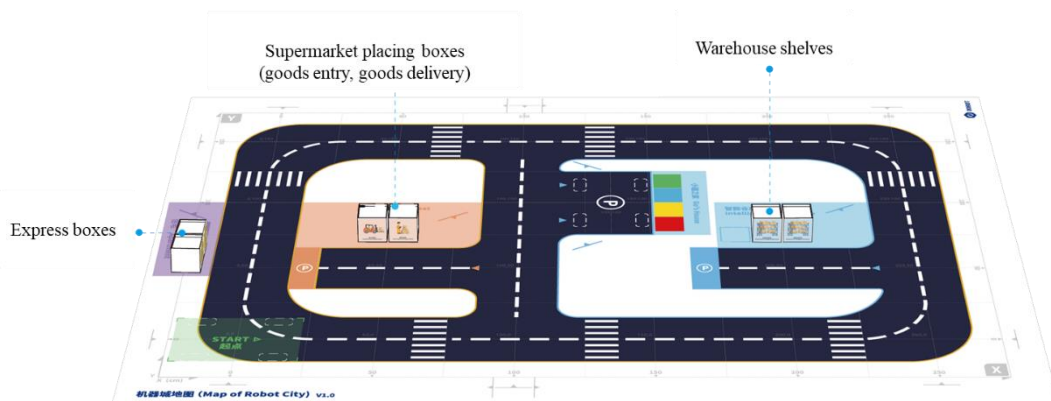

Figure 5.6 Position of placing boxes

- Express boxes include international express, domestic express and Intra-city express, as shown in Figure 5.5. When simulating express delivery, please place the express according to the suggested position in Figure 5.7, and ensure that the express box is placed on the intelligent warehouse shelf or intelligent express cabinet.

Table 5.5 Express box

Icon	Description
	International express
	Domestic express
	Intra-city express

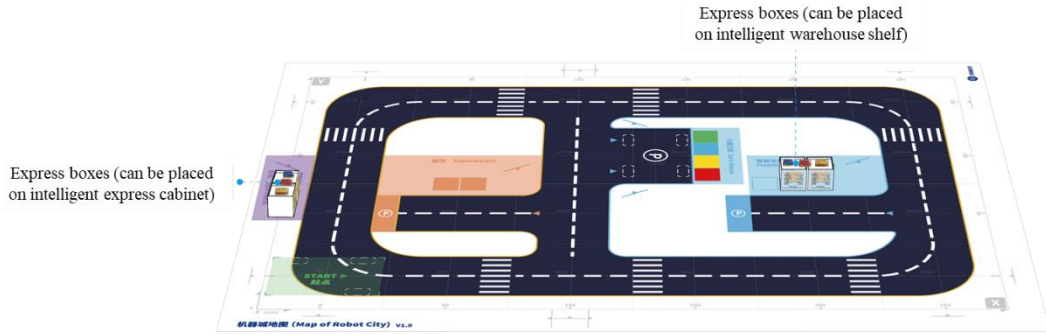





Figure 5.7 Position of express boxes

4. Props include orange, cabbage and mineral water, as shown in Table 5.6. When simulating in supermarket or intelligent warehouse, please place the props according to Figure 5.8, and ensure that the props are placed on the placing boxes of intelligent warehouse shelf or the supermarket.

Table 5.6 Props

Icon	Description
	Orange
	Cabbage
	Mineral water

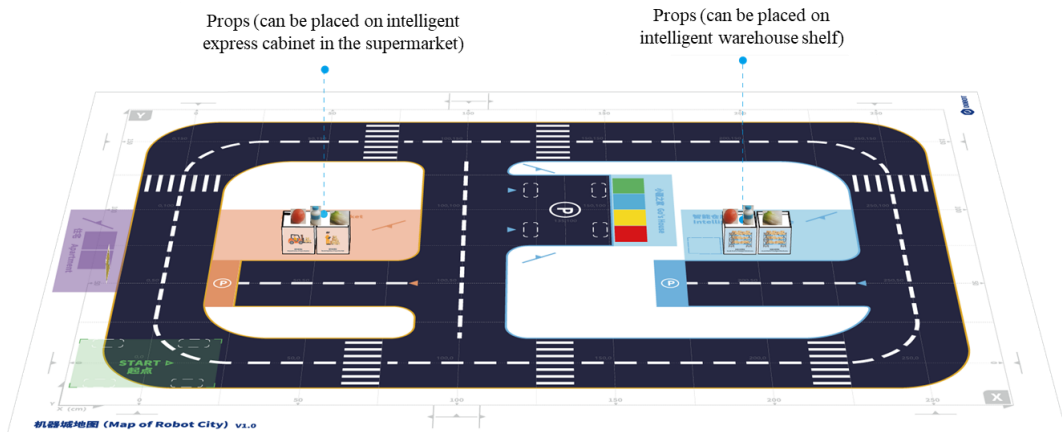

Figure 5.8 Position of props

NOTE

- When placing express boxes and props, keep a certain distance between two objects, which can improve the success rate of grasping.

- Mineral water props need to laid on its side, otherwise it may cause failure in capturing.

5.2 Reset

Magician Go is calibrated with the coordinates corresponding to the center point of the car body, as shown in Figure 5.9. If Magician Go is used with the map, it must be reset at “START” point in the map, otherwise the starting coordinates of Magician Go (0,0) will be inconsistent with the starting point of the map, and you cannot accurately position the coordinates on the map.

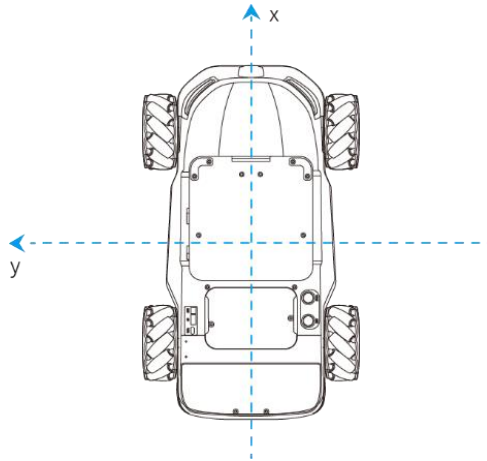

Figure 5.9 Center of Magician Go

Reset operation is to clear the coordinate information of Magician Go, and set the current position as the starting coordinates (0,0) of Magician Go. the front direction for the X direction. The specific steps are as follows:

Step 1 Place Magician Go at “START” point on the map.

Magician Go's four wheels are aligned with four dotted boxes, with the car front facing the "X" axis positive direction of the map in, as shown in Figure 5.10.

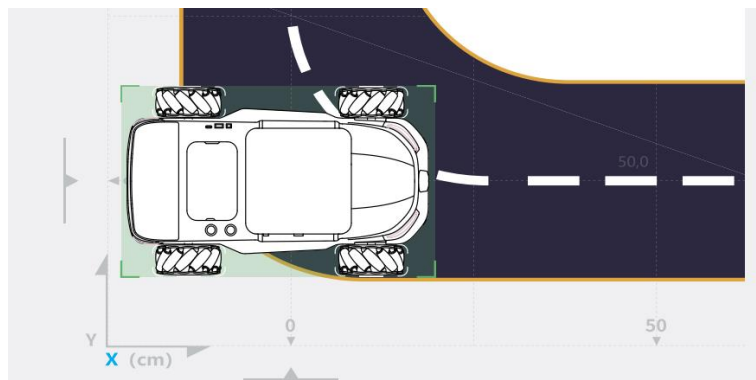

Figure 5.10 Place Magician Go at “START” point on the map

Step 2 Enter <https://dobotlab.dobot.cc/> in the browser and enter Python Lab. After connecting corresponding device, you can perform reset operation:

- Click “Reset” on chassis control panel.

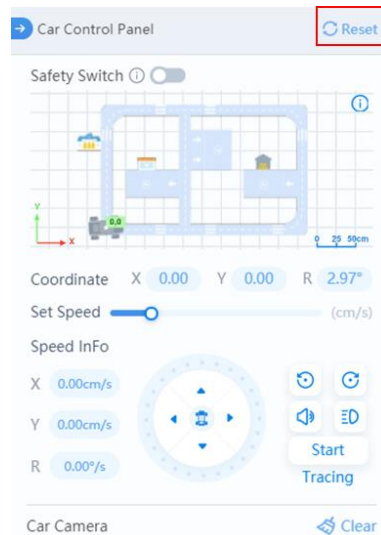

Figure 5.11 Click “Reset”

- Or execute “Set odometer data” command when writing programs. You need to set all the parameters to 0. (`go.set_odometer_data(x=0, y=0, yaw=0)`)

5.3 Demo

The demo in this section has been loaded into Magic Box of Magician Go before delivery. You can log in Yuejiang website (<https://cn.dobot.cc/downloadcenter/dobot-magician-go.html>) to download.

5.3.1 Road sign detection demo

5.3.1.1 Introduction

Magician Go performs line patrol task on the map. You use  sign to order Magician Go parking check. After checking, you take out the sign, and Magician Go continues to perform line patrol on the map.

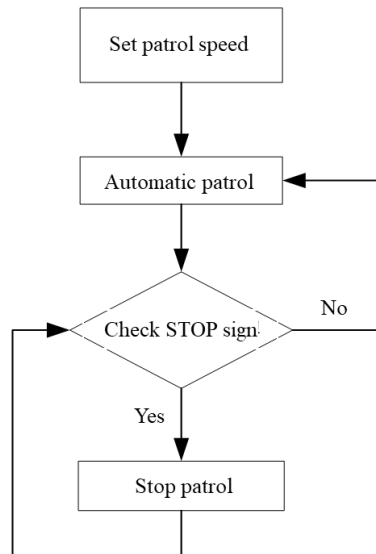

Figure 5.12 Procedure for road sign detection

5.3.1.2 Procedure

- Step 1** Place Magician Go on “START” point, as shown in Figure 5.13.
- Step 2** Place  sign on the guide line of the map and make sure the front of the sign faces Magician Go’s head, as shown in Figure 5.13.



Figure 5.13 Position of Magician Go and STOP sign

- Step 3** Press the Power button on Magic Box. Select Script in Magic Box and press OK button. On Script page, select the Guide Sign Detection script.
- Step 4** Click OK. The script starts running. If the corresponding road sign is detected, Magician Go will stop line patrol, otherwise it will continue.

5.3.1.3 Code description

1. Set patrol speed

```

go.set_trace_speed(speed=20)
beta_go.set_ptp_car()
    
```

2. Start automatic patrol

```
go.set_auto_trace(trace=1) # Start automatic patrol
```

3. Check STOP sign

```
while 1:
if beta_go.car_camera_is_detected(sign_name="stop"): # Checked STOP sign
go.set_trace_speed(speed=0) # Stop patrol (speed is 0)
go.set_auto_trace(trace=0) # End automatic patrol
if not beta_go.car_camera_is_detected(sign_name="stop"): # Checked no STOP sign
go.set_trace_speed(speed=20) # Set patrol speed
go.set_auto_trace(trace=1) # Start automatic patrol
```

5.3.2 Color cube sorting demo

5.3.2.1 Introduction

Magician Go and Magician Lite can simulate objects to be placed according to different categories (blocks in different colors represent different objects), and Magician Lite places blocks on the corresponding placing boxes.

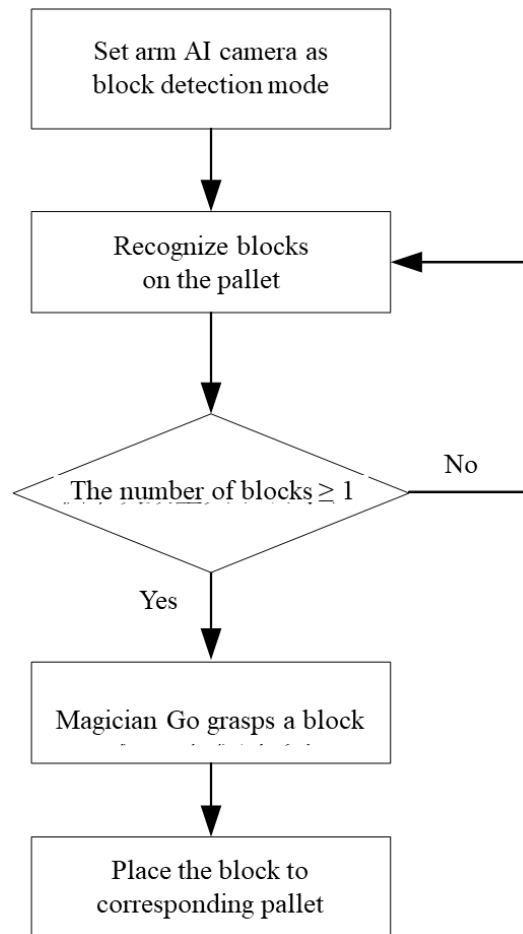

Figure 5.14 Procedure of block sorting

5.3.2.2 Procedure

Step 1 Place Magician Lite into the arm installation slot of Magician Go, and connect the wires.

The wire connection of Magician Lite is described in 3.2 *Wiring of Magician Lite*. Magician Lite needs to be used with AI camera. Please see 3.3 *Wiring of arm AI camera* for details.

Step 2 Place Magician Go to the specified position of “Go’s Home”.

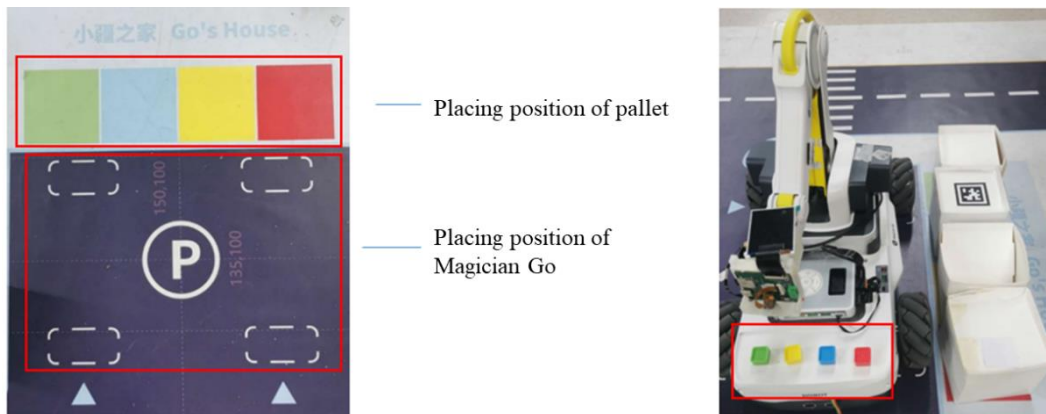

Figure 5.15 Position of Magician Go

Step 3 Place four placing boxes at the specified position of “Go’s Home”

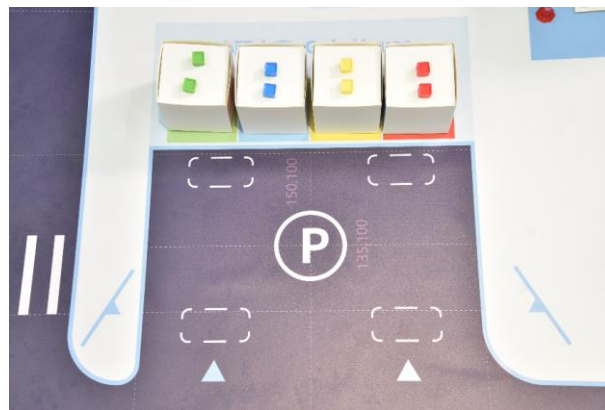

Figure 5.16 Position of placing boxes

Step 4 Place matching blocks of Magician Lite on the pallet of Magician Go.



Figure 5.17 Position of blocks

Step 5 Press the **Power** button of Magic Box, select **Script** in Magic Box, and click **OK** button of Magic Box. On the Script page, select **Colorful Cubes Sorting** script.

Step 6 Press **OK**. The script starts to run.



Figure 5.18 Script starts to run

5.3.2.3 Key code description

1. Set arm AI camera as block detection mode.

```
beta_go.set_arm_camera_model(index=1)
```

2. Identify the color of blocks on the pallet of Magician Go and randomly select one block

while True:

```
beta_go.set_ptp_car()           # The arm extends to the top of the pallet
time.sleep(1)                   # Delay for 1s until the arm stabilizes
datalist = go.get_arm_camera_obj() # Get information from the arm camera
if datalist["count"]:           # If there are blocks on the pallet
grab_ind = randint(0,int(datalist["count"])-1) # Pick a block randomly
```

3. Grab blocks

```

grab_obj = datalist["dl_obj"][grab_ind] # Get information of the block
x_c = grab_obj["x"]+grab_obj["w"]/2 # Calculate the coordinates of the block center point
y_c = grab_obj["y"]+grab_obj["h"]/2
p_x, p_y = beta_go.imgxy_to_armxy(x_c, y_c, 0) # Convert to arm coordinates
m_lite.set_ptpcmd(1, p_x, p_y, 10, -80.0887) # The arm moves directly above the block
m_lite.set_ptpcmd(1, p_x, p_y, -8, -80.0887) # Reach grab position
m_lite.set_endeffector_suctioncup(enable=True, on=True) # Suck up the block
    
```

4. Place blocks to corresponding pallets

```
place_cube(grab_obj["id"])
```

NOTE

- Place_cube () is a self-defined function for placing blocks, which has been built into the color cube sorting demo with the following code.

```

def place_cube(object_id):
    beta_go.set_ptp_car()
    beta_go.set_ptp_floor()
    time.sleep(0.05)
    # Place red cubes on the placing boxes in red area
    if object_id == 0: # red
        # Move above the box into which the red cube is to placed
        m_lite.set_ptpcmd(1, 209.0919, -194.3939, 35.2920, 0)
        time.sleep(0.05)
        # Release the suction cup
        m_lite.set_endeffector_suctioncup(enable=False, on=True)
        # Place yellow cubes on the placing boxes in yellow area
        elif object_id == 1:# yellow
            m_lite.set_ptpcmd(1, 209.0919, -84.3942, 35.2920, 0)
            time.sleep(0.05)
            m_lite.set_endeffector_suctioncup(enable=False, on=True)
        # Place blue cubes on the placing boxes in blue area
        elif object_id == 2:# blue
            m_lite.set_ptpcmd(1, 209.0919, 37.0856, 35.2920, 0)
            time.sleep(0.05)
            m_lite.set_endeffector_suctioncup(enable=False, on=True)
        # Place green cubes on the placing boxes in green area
        elif object_id == 3:# green
            m_lite.set_ptpcmd(1, 209.0919, 149.0859, 35.2920, 0)
            time.sleep(0.05)
            m_lite.set_endeffector_suctioncup(enable=False, on=True)
        m_lite.set_ptpcmd(1, 224.3980, 0.0000, 148.7624, 0)
    
```

5.3.3 Intelligent logistics

5.3.3.1 Introduction

Magician Go and Magician Lite perform the logistics delivery task: deliver the express in the intelligent warehouse to the residence, and the fresh goods to the supermarket.

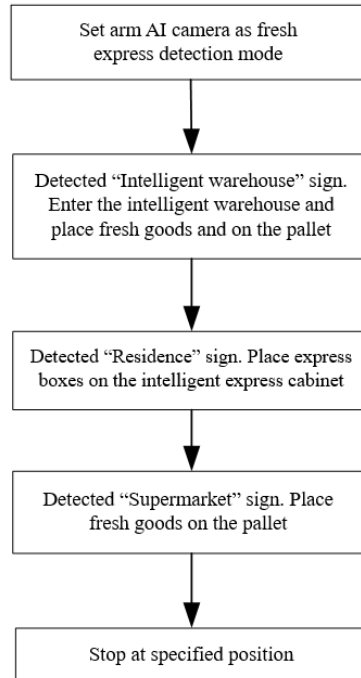

Figure 5.19 Procedure of intelligent logistics

5.3.3.2 Procedure

Step 1 Place Magician Lite into the arm installation slot of Magician Go, and connect the wires.

The wire connection of Magician Lite is described in *3.2Wiring of Magician Lite*. Magician Lite needs to be used with AI camera. Please see *3.3Wiring of arm AI camera* for details.

Step 2 Place Magician Go and Magician Lite at “START” point.

Step 3 Place guide signs, props and express boxes to the specified position according to Figure 5.5, Figure 5.6, Figure 5.7 and Figure 5.8.

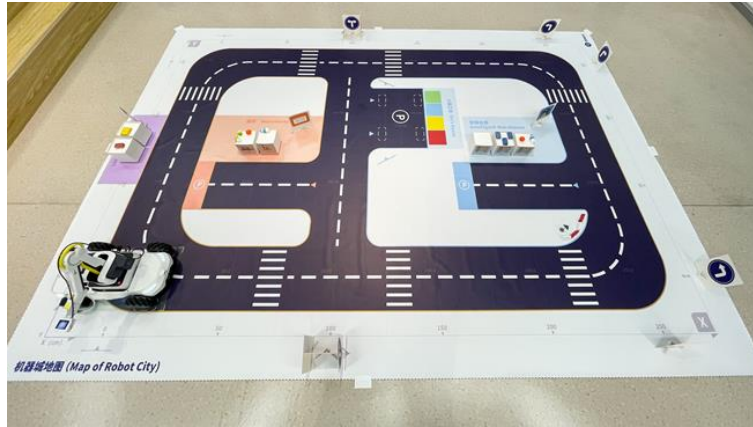

Figure 5.20 Position of guide signs, props and express boxes

Step 4 Press the **Power** button of Magic Box. Select **Script** in Magic Box, and press **OK** button. On the Script page, select **Intelligent Logistics** script.

Step 5 Press **OK**. The script starts to run.

The position of Magician Go, placing boxes and express, fresh goods is shown as figure above.

5.3.3.3 Code description

1. Reset

```
go.set_odometer_data(x=0, y=0, yaw=0)
```

2. Set speed of line patrol, and start automatic line patrol

```
go.set_trace_pid(p=0.5, i=0, d=0.5)
```

```
go.set_trace_speed(speed=20)
```

```
go.set_auto_trace(trace=1)
```

3. Set arm AI camera as fresh express detection mode

```
beta_go.set_arm_camera_model(index=3)
```

4. Enter intelligent warehouse. Magician Lite grabs props and express boxes and place them to the pallet pf Magician Go

```
if beta_go.car_camera_is_detected("wh"): # Detected "Intelligent Warehouse" sign
```

```
    beta_go.stop_point(point=[250, 50], scope=20, err=2) # Magician Go stops
```

```
    go.set_rotate(r=90, Vr=40) # Set turning speed and distance
```

```
    beta_go.into_park_space(garage_class=0) # Magician Go enters the parking space of intelligent warehouse
```

```
    beta_go.grab_obj_floortocar(object_class=0) # Magician Lite grabs props and express boxes
```

```
    beta_go.out_park_space(garage_class=0) #Magician Go leaves the parking space
```

```
    go.set_rotate(r=-90, Vr=40) # Set turning speed and distance
```

```
    go.set_auto_trace(trace=1) # Continue to patrol
```

5. If detects "Residence" sign, place express boxes on the pallet of Magician Go to intelligent express cabinet

```
while cycle2:
```

```
    if beta_go.car_camera_is_detected("apt"): # Detected "Residence" sign
```

```
beta_go.stop_point(point=[0, 75], scope=20, err=2) # Magician Go stops
beta_go.grab_obj_cartofloor(object_class=2) # Place express boxes
go.set_auto_trace(trace=1) # Continue to patrol
```

6. If detects “Supermarket” sign, place props on the pallet of Magician Go to supermarket placing boxes

```
while cycle3:
if beta_go.car_camera_is_detected("spm"): # detected "Supermarket sign"
beta_go.stop_point(point=[100, 50], scope=20, err=2) # Magician Go stops
go.set_rotate(r=90, Vr=40) # Set turning speed and distance
beta_go.into_park_space(garage_class=1) # Magician Go enters the parking space of supermarket
beta_go.grab_obj_cartofloor(object_class=1) # Place the props
beta_go.out_park_space(garage_class=1) #Magician Go leaves the parking space
go.set_rotate(r=-90, Vr=40) # Set turning speed and distance
go.set_auto_trace(trace=1) #Continue to patrol
```

7. Stop at specified position

```
beta_go.stop_point(point=[100, 100], scope=20, err=2)
cycle1 = False
cycle2 = False
cycle3 = False
break
```